

VF2 SERIES NSF/ANSI2 FOOD ZONE LINEAR HIGHBAY



Project:	
Type:	
Catalog #:	



Wattage & Color
Changing High Bay

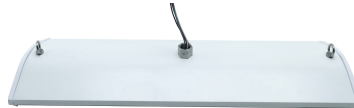

FEATURES

- High performance LED LUXEON SMD
- Lumen output 12,000 to 45,000 lumens
- Efficacy Up To 150lm/W
- LED Lifespan> 50,000 hours (Ta=30°C @L70).
- CCT: 3000K 4000K 5000K 6000K (5000K standard). RGB, Germicidal options available (consult factory).
- Aluminum alloy (AL6063) housing with white epoxy powder coat finish standard (Unpainted AL6063 available)
- 0-10V dimming. 80W-200W uses single driver, 300W uses double drivers.
- Consult factory for custom cord and wiring options. Fixture comes standard with 3ft whip and IP69K waterproof connector.
- Polycarbonate lens - safe for food processing applications.
- External PIR sensor (IP65) and motion sensor options available.

MECHANICAL

- Robust AL6063 housing withstands harsh industrial environments.
- Stainless Steel suspended mounting cable and surface mounting brackets options available.
- Standard with mounting loops for chain hanging.
- Achieves -40C-55C ambient rating. Good for cold storage and high heat applications.

ELECTRICAL

- 100-277V Standard. 200-480V available
- CCT: 3000K, 4000K, 5000K, 6000K ,RGB Germicidal
- Up to 150lm/W

CONTROL OPTIONS

- Unit mounted dipswitches - CCT and wattage tunable
- Phone app/BlueTooth - TUYA: CCT and dimmable
- ZIGBEE - WiFi Gateway (contact factory)
- Rockwell PLC Control (contact factory)

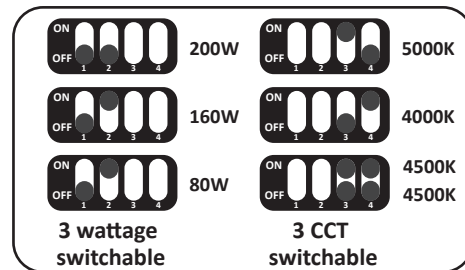

WARRANTY AND LISTING

- UL 1598-2008
- DLC premium
- IP69K rated
- NSF/ANSI 2 (approved for food zone non-contact, splash zone, and non-food zone)
- 1500psi hosedown
- -40°C to 55°C Cold Storage/High Temp (contact factory for 65°C)
- 5 year warranty @ 24 hour operation

ORDERING INFORMATION

SERIES	WATTAGE	VOLTAGE	CCT	CRI	OPTIC	DRIVER	ACCESSORIES
VF2	8 = 80W	LV = 120-277V	S = 3000K	7 = 70	15°	D* = Dimmable	CL** = Cable Length
	12 = 120W	HV = 200-480V	I = 4000K	8 = 80	25°	ND = Non Dimmable	MS = Microwave Sensor 60C rated
	16 = 160W		C = 5000K	85= 85	40°		PIR***= Passive Infrared Sensor 35C rated
	20 = 200W		K = 6000K		60°		DS = Dip-switch (Tunable)
	30 = 300W		N = 4K,45K,5K		90°		MS-T = Bluetooth Tuya phone app
	WT = 80W,160W,200W		Tunable		120°		AH= Aluminum Housing no paint
	Tunable		C = CUSTOM		30° x 15°		PM = Pendant mount 3/4" Conduit Hub
WT-1 = 300,250,200	Tunable		R = Red		49° x 21°		SM= Surface mount (no loops)
			G = Green		136° x 78°		ZT = ZIGBEE
			B = Blue				

*Adds dimming wire to top

**Specify cable length.

***Only IP65

NOTE: ORDER REMOTE OPTION FOR PIR AND MICROWAVE SENSORS TO CHANGE SETTINGS

RP = Rockwell PLC Control

BT = Bluetooth (Phone Tuya App)

TECHNICAL PARAMETERS

Power	80W	120W	160W	200W	250W	300W
Input Voltage	AC100-277V/AC200-480V, 50/60HZ					
Power Factor	>0.95					
Working Temperature	-30°C~45°C					
Lumen Efficacy	150lm/w					
Lumen	12000 lm	18000 lm	24000 lm	30000 lm	37,500	45000 lm
Color Temperature	3000K-6500K					
Beam Angle	15°/25°/40°/60°/90°/120°/30°X15°/49°X21°/136°X78°					
CRI	Ra>70/Ra>80					
Housing Color	White Aluminum					
Lifespan	>50.000 hours@L70					
Fixture Dimension	448*250*69mm	556*250*69mm			810*250*69mm	

BEAM ANGLE

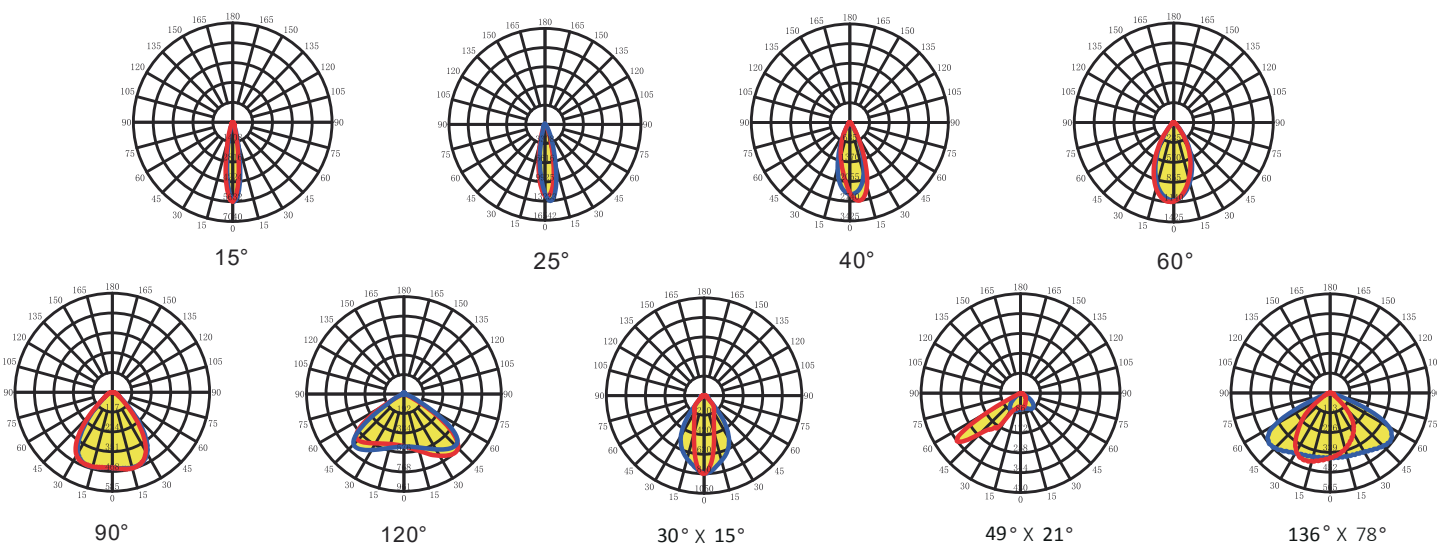

Options:

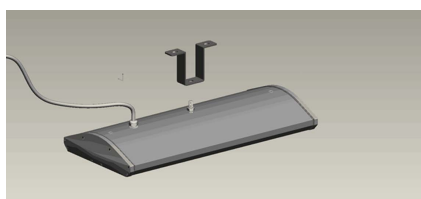

Stainless Steel Surface mount bracket with power wire, no dimming

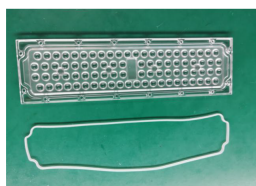

Field Interchangeable Lenses

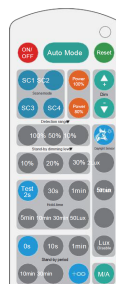

HANDHELD CONTROLLER
HC-1 (PIR)
HC-2 (Microwave)

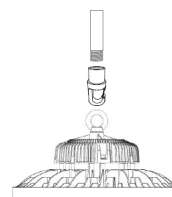

¾" Conduit-Mounted (VICOHBRSN-PSH-PRM)



Chain/hook mounting kit
CHMK-1



Linear Red Enhanced Lighting System provides a more uniform and continuous light pattern free of dark spots and shadows. Birds are less likely to be spooked or provoked by movement outside of the systems. As a result, these birds are noticeably less-stressed and calmer. This lighting system reduces electricity costs, decreases labor and maintenance costs, and increase flock performance.

Linear Red Enhanced Lighting has a deep red saturated light output with an added blue and green spectrum, benefiting the vision of the animals. The enhanced red spectrum is the only spectrum which stimulates a hen's hypothalamic and pineal oscillators, helping maintain circadian rhythms and promoting sexual maturity. It also stimulates the release of two reproduction regulating hormones essential for daily egg production.

SWINE LIGHTING SYSTEMS

These particular lighting systems are designed to provide exceptional light quality for both the swine herds and the humans caring for them. They are made with species-specific dim-to-red-calm technology and are suitable to be used in sow barns, gestation buildings, nurseries, gilt development units, and finishing facilities. Our technology allows the lighting fixture to fully dim red, which swine perceive as darkness. This allows the red light to be used as a "service light," allowing workers to access the facility without disturbing or interrupting the sleep cycles of the animal.

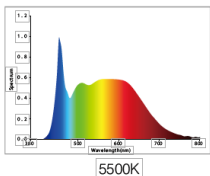

PRODUCTIVITY ENHANCEMENT

Under full spectrum plus dim to 0.2% technology, birds are calmer, less prone to run, not as jumpy, and consequently put more energy into growing.

By having more red spectrum during brooding, LED lights promote early growth. Research tests and on-farm testing have both shown immediate changes in bird behavior and improved feed conversion ratios when the lights are dimmed to the lower levels of blue enhanced spectrum.

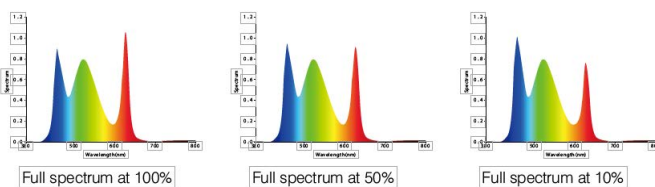
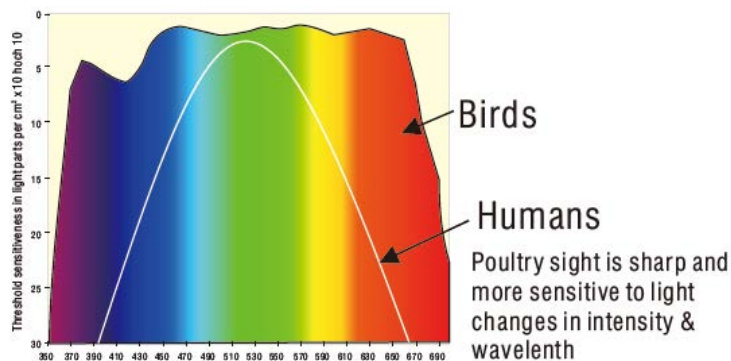

【Product Feature】

- Thimble interface; Earphone interface; Zhaga interface
- 12 meters maximum installation height, suitable for most warehouses
- Mini Microwave motion detector for High Bay Lights.
- IP65 design
- Sensor parameters can be adjusted by remote
- High mounting PIR sensor

PIR sensor factory Default setting is:
Sensitivity: 100%, Hold time: 5s, Daylight sensor: Disable, Stand by period: 0s



MC079D IR A

MC079D IR DI

MC079D IR Z

【Parameters】

Input				
Rated voltage	12±1VDC			
Operating Voltage	12V DC			
Ripple voltage	<100mVp-p			
output				
Output signal	☑0 -10VDC dimming signal			
Sensor parameters				
Detection mode	PIR detection			
Daylight priority	Switch ON	5Lux/15Lux/30Lux/50Lux	100Lux	150Lux
	Switch OFF	150Lux	200Lux	300Lux
Dimming level	10%, 20%, 30%, 50%			
Detection range (radius)	2-4m (indoor,sensitivity 100%,no direct sunlight to sensor)			
Installation height	Typical 10m (12m Max)			
Environment				
Working temperature	0~35℃			
Storage temperature	-20℃~+80℃ Humidity: 10%-95% (non-condensing)			
Certification standards				
Certified	UL 8750(Pending)			
Environmental requirements	Comply with RoHS 2.0 , Reach requirements			
IP Rating	IP65			

Other	
Wiring	Thimble interface
Installation requirements	Mount center or side of highbay
Packaging requirements	Clapboard + Carton(K=A)
Net weight	80g
Lifetime	3 years warranty @Ta

【Function description】

- ON-OFF function Stand-by Period be set to “0s”
- 2-step dimming Stand-by Period be set to “+∞”
- 3-step dimming Stand-by Period be set to “10s/1min/3min/5min/10min/30min”
- Daylight priority Remote press DH Mode and Daylight Sensor be set to “5Lux/15Lux/30Lux/50Lux/100Lux/150Lux”
- Daylight harvesting N/A

【Product Information】

- Dimension (Unit: mm)

PIR sensor factory Default setting is: Sensitivity: 100%, Hold time: 5s, Daylight sensor: Disable, Stand by period: 0s

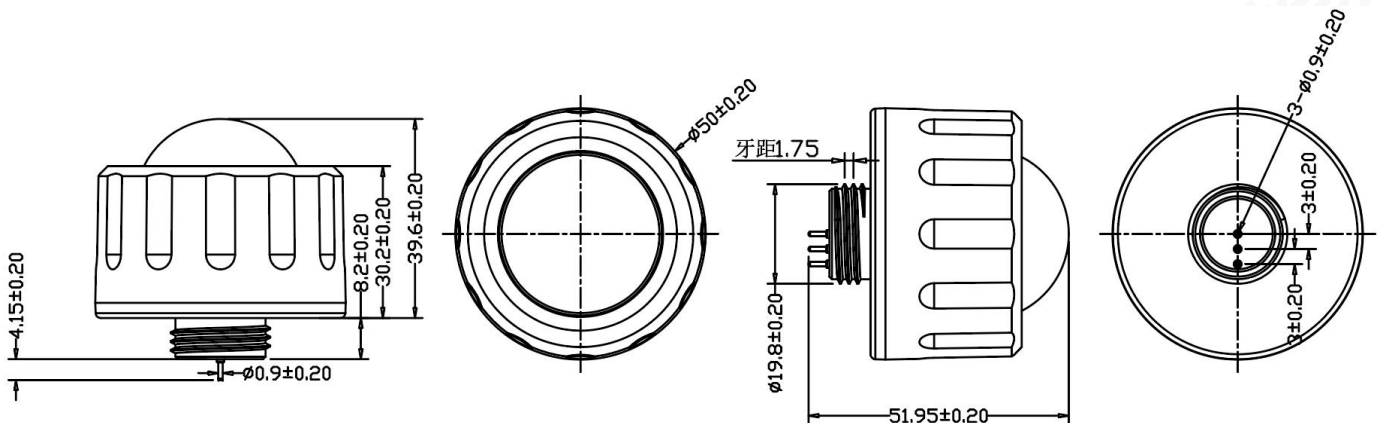

MC079D IR A

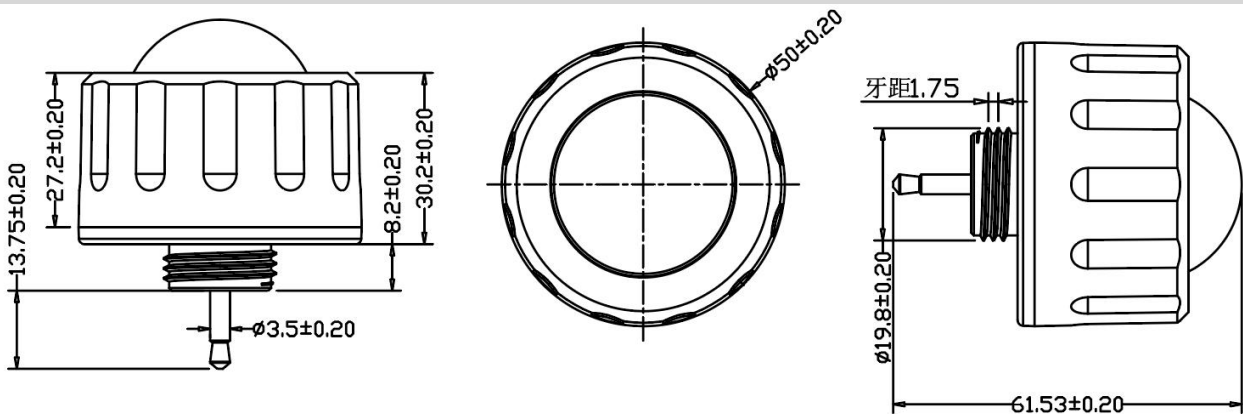

MC079D IR DI

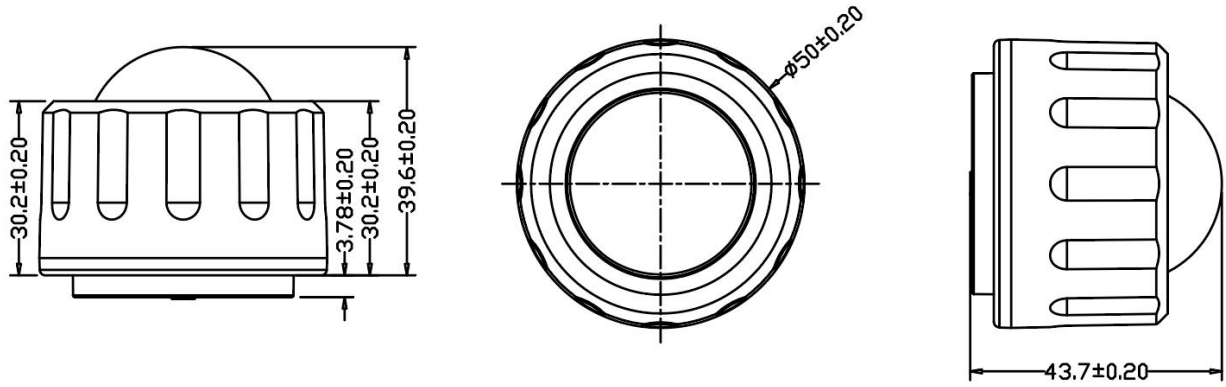

MC079D IR Z

● Function

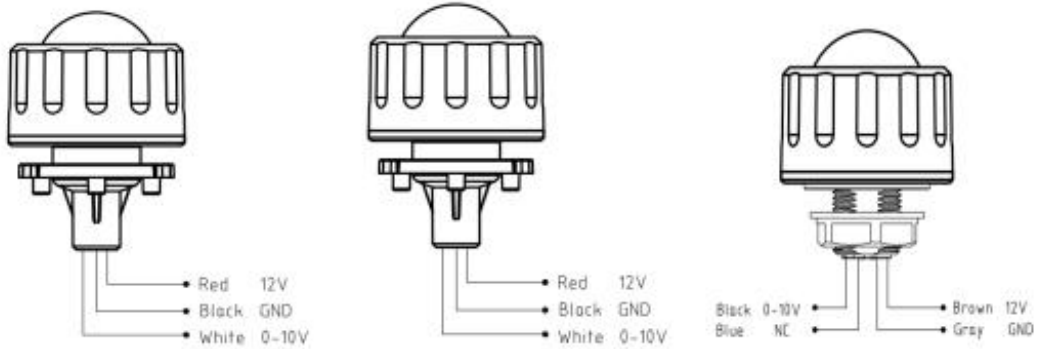
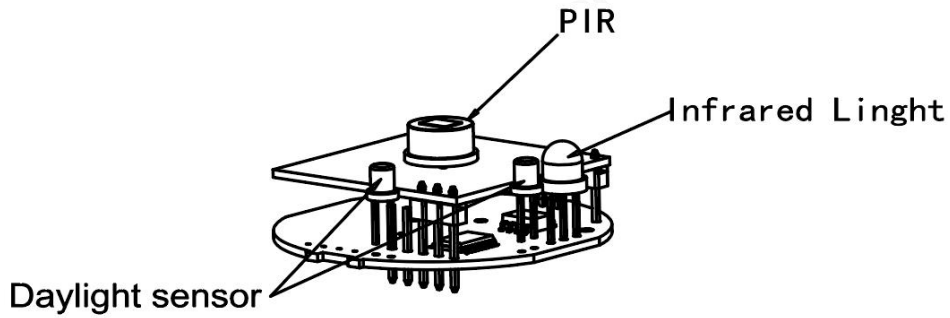

● Wiring

MC079D IR A

MC079D IR DI

MC079D IR Z

● Installation Instruction

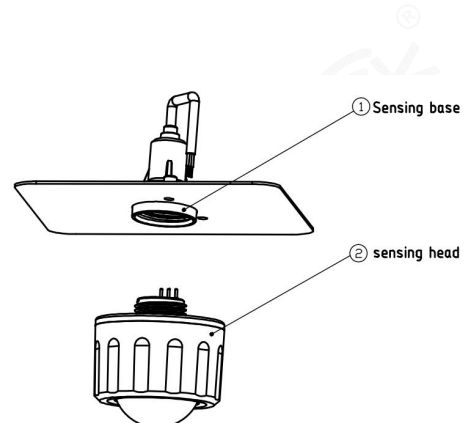
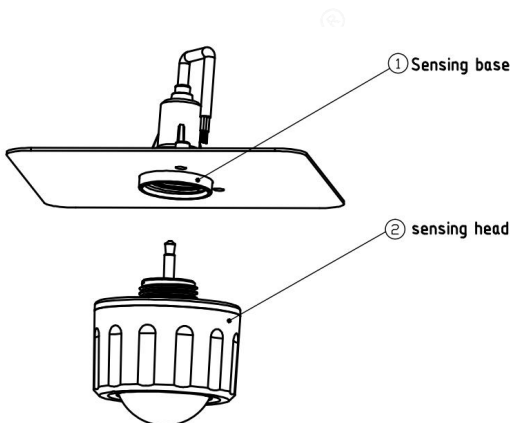

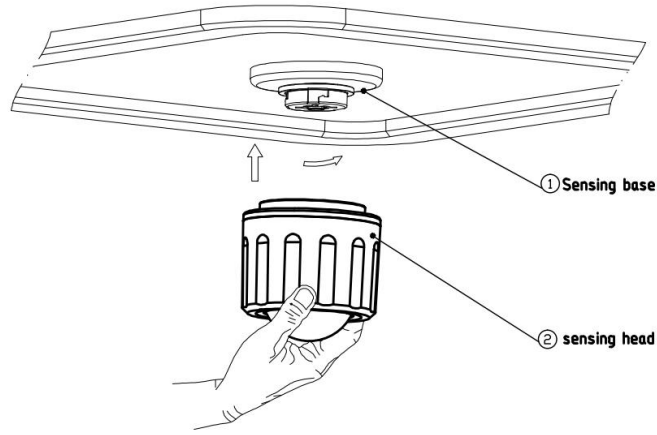

【Detection Range】

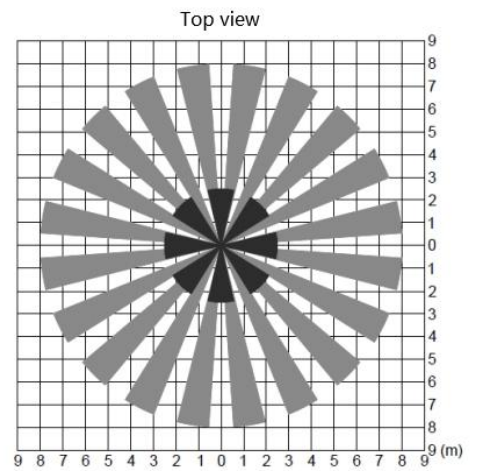
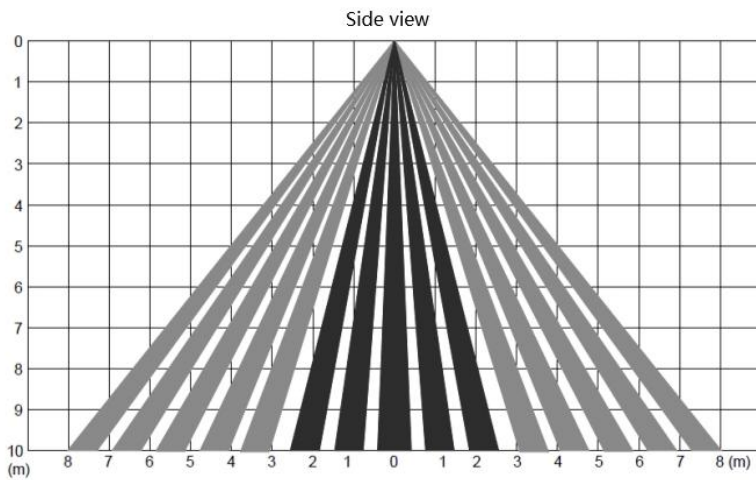

PIR sensor factory Default setting is: Sensitivity: 100%, Hold time: 5s, Daylight sensor: Disable, Stand by period: 0s

【Retome】

- MH12

Detection area	Short press to set detection area 25% / 50% / 75% / 100%, long press (>3s) to transmit selected value.
Send	Short press to transmit all selected value on remote screen.
Stand-by Period	Short press to set standby period 0S / 30S / 1min / 3min / 5min / 10min / 20min / 30min / +∞ Long press >3s to transmit selected value
Stand-by DIM Level	Short press to set standby dimming level 10% / 20% / 30% / 50%. Long press >3s to transmit selected value
Hold Time	Short press to set hold time 0S / 30S / 1min / 3min / 5min / 10min / 20min / 30min., Long press >3s to transmit selected value
Auto Mode	Short press to set working mode: MD=Motion-daylight threshold; MP=Motion+Daylight priority (daylight switch) / Daylight harvesting; P= Daylight priority / Daylight harvesting; Long press >3s to transmit selected mode Note: MP or P is not available for all modes, please follow spec. sheet of motion sensor.
Daylight Threshold	Short press to set Daylight threshold 5Lux / 15Lux / 30Lux / 50Lux / 100Lux / 150Lux / Disable. Long press >3s to transmit selected value When set Daylight threshold to Disable sensor will switch on light when detect motion regardless of ambient brightness level.
Motion Sensor	Short press to quit from constant on/off mode, sensor start to work (the previous setting stays in validity)
Dim+/Dim-	Short press to set occupancy light level 50%-100% in MD mode; Set target lux level in MP(Motion+Daylight harvesting) mode Dim level will change 5% each time press this button
Reset	Short press to return to factory default setting.
S	NA for user
H/L	NA for user
2	2nd optional quick setting, short press to show the setting configuration, long press >3s to save this configuration. Press "Send" to transmit selected quick setting
1	1st optional quick setting, short press to show the setting configuration, long press >3s to save this configuration. Press "Send" to transmit selected quick setting
ON/OFF	Short press to switch on/off light, sensor function will recover after turn off and on power Long press >3s to switch on/off light, sensor function won't recover only if press "Motion sensor"

Detection Area	Hold Time	Daylight sensor	Stand-by period	Stand-by dim level
100%	5s	Disable	0s	10%

Remote Control Setting	Button	Remarks																												
	ON/OFF	Press the "ON/OFF" button, the light goes to constant on/off mode, sensor is disabled. Press Sensor motion to quit from this mode and the sensor starts to work. The button have power-off memory function																												
	Reset	Press "Reset" button, all parameters are same as setting of DIP switch or factory settings.																												
	Sensor motion	Press "Sensor motion" button, the light quits from the constant on/ off mode, and the sensor starts to work (The latest setting stays in validity)																												
	DIM Test	Press "DIM Test" button, the 0-10 V dimming works to test whether the 1-10Vdc dimming ports are connected properly. After 2s, it returns to the latest setting automatically.																												
	DIM+ DIM-	Short press "DIM+/DIM-" button to transmit dimming signal. The brightness of the lamp adjusts at 5% per unit. (only apply for sensor with daylight harvesting function)																												
	DH Mode	Long Press 3S to enter the Daylight priority function Long Press 3S "Override DH" button to exit the Daylight priority mode and enter the Daylight Sensor mode Short press "Disable" button to exit the Daylight priority mode and the Daylight Sensor mode to enter the normal induction mode																												
	Q1 Q2 Q3	<table border="1"> <thead> <tr> <th>Scene Options</th> <th>Detection Area</th> <th>Hold Time</th> <th>Stand-by period</th> <th>Stand-by dim level</th> <th>Daylight Sensor</th> <th>Induction model</th> </tr> </thead> <tbody> <tr> <td>Q51</td> <td>100%</td> <td>5min</td> <td>10min</td> <td>10%</td> <td>30Lux</td> <td>Hs</td> </tr> <tr> <td>Q52</td> <td>100%</td> <td>10min</td> <td>30min</td> <td>10%</td> <td>Disable</td> <td>Hs</td> </tr> <tr> <td>Q53</td> <td>100%</td> <td>20min</td> <td>30min</td> <td>10%</td> <td>Disable</td> <td>Hs</td> </tr> </tbody> </table> <p>Note: Detection area / Hold time / Stand-by period / Stand-by dim level / Daylight sensor can be adjusted by pressing the corresponding button. The latest setting will stay valid.</p>	Scene Options	Detection Area	Hold Time	Stand-by period	Stand-by dim level	Daylight Sensor	Induction model	Q51	100%	5min	10min	10%	30Lux	Hs	Q52	100%	10min	30min	10%	Disable	Hs	Q53	100%	20min	30min	10%	Disable	Hs
Scene Options	Detection Area	Hold Time	Stand-by period	Stand-by dim level	Daylight Sensor	Induction model																								
Q51	100%	5min	10min	10%	30Lux	Hs																								
Q52	100%	10min	30min	10%	Disable	Hs																								
Q53	100%	20min	30min	10%	Disable	Hs																								
	TEST 2S	Press the "TEST 2S" button can enter the test mode anytime. At the mode, the sensor parameters as below: Detection Area is 100%, Hold Time is 2s, Stand-by Dim Level is 10%, Stand-by Period is 0s, daylight sensor disable. This function only for testing. Quit the mode by pressing "RESET" or any other function buttons.																												
	HS LS	N/A																												
	Daylight Sensor	Set up daylight threshold: 5Lux/15Lux/30Lux/50Lux/100Lux/150Lux/ Disable																												
	Stand-by period	Set up stand-by time: 0S/10S/1min/3min/5min/10min/30min/+∞																												
	Hold time	Set up hold time: 5S/30S/1min/3min/5min/10min/20min/30min																												
	Stand-by dim level	Set up stand-by dim level: 10%/20%/30%/50%																												
	Detection Area	Set up detection area: 25%/50%/75%/100%																												
	Remote Distance	Toggle bottom can set the remote distance of remote control and sensor.																												

Remote control and code setting conversion

1. DIP switch setting convert to remote control Press any bottom except "RESET" on the remote control, and the sensor settings convert to the function currently selected by the remote control.
(No function button settings invalid)

2 remote control convert to DIP switch setting

- Press the "RESET" button on the remote control, and all settings return to the DIP switch settings of the sensor.
- Turn off the power, toggle any DIP switch, connect to the power, and all settings return to the DIP switch settings when supply power again.

Unique design of infrared transmitting device

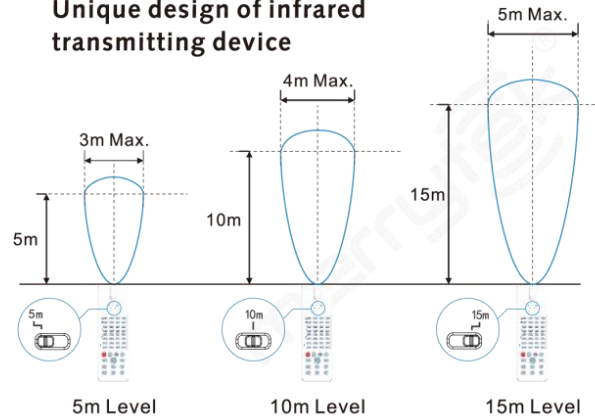

【Initialization】

After switch on power, sensor will be warmed 45-60s then start to work.

【Default setting】

Sensitivity: 100%, Hold time: 5s, Daylight sensor: Disable, Stand by period: 0s

【Application Notice】

- The sensor should be installed by a professional electrician. Please turn off the power before installing, wiring and changing parameters.
- PIR sensor can't penetrate any materials, please make sure no obstacle between sensor and moving people/object.
- Sensor may hard to detect people if wear thick clothes in cold winter.
- Heat signals will be regarded as moving signals to trigger the sensor. Avoid facing sensor to air condition or other heating source.
- Sensor is for indoor use only. Outdoor sunlight could affect the detection of sensor.
- Due to continuous improvement, the contents of this instruction could be changed without prior notice.
- The dimming performance could be different when work with different 0-10V drivers.
- The daylight threshold is measured in a sunny environment without shadow and ambient light diffuse reflection. Ambient lux level could be different in different environment, weather, climate, time-of-day and season.
- Detection distance is related to height of people, mounting height, mounting angle, working environment, and etc.
- Given detecting area is typical value that was measured by 165cm high testers in an indoor open environment.
- This product have to use with voltage-stabilized DC power supply whose input voltage is stable and ripple factor is low(ripple factor is lower than 100mV; load current is greater than 25mA).
- When installing in new environment, please install and test at least 5pcs product firstly before mass installation.





SPECIFICATION

Product Name: High Bay Sensor for Warehouse

Model No.: MC079D RC Z

Issue Date: March 17, 2021

CUSTOMER APPROVED

PRODUCT DIRECTOR APPROVED	SALES CHECKED	R&D CHECKED	PREPARED
			

Shenzhen Merrytek Technology Co.,Ltd

Add: No.17th Building, Dianda Guyuan Industrial Park, Mashantou, Matian, Guangming District, Shenzhen, China, 518106

Tel: +86 (0)755-2305 7253

Fax: +86 (0)755-2786 3012

Website: www.merrytek.com

*Please read the 12th instruction carefully before using this product, since the performance of DC-powered microwave products is closely related to the stability and characteristics of the auxiliary power supply of the LED driver.

1. Features



- 12V DC input, for DC systems or LED power supplies with 12V DC auxiliary power output
- 0-10V dimming port, 3 or 2 step dimming function
- Newly patent design sensor antenna with two detection mode: high sensitivity detection and interference immunity detection. (suitable for installation environments with many metal reflective surfaces)
- 15m maximum installation height, suitable for most warehouses
- Match Zhaga Book 18 base, plug in design
- Dim+/Dim- to set occupancy light level
- Daylight priority function
- 5 years warranty

2. Parameter

Input	DC Input Voltage	12 DC ±1V
	Rated Voltage	12V DC
	Voltage Ripple	<300mVp-p
	Stand-by Power	<0.3W
	Wiring	By Zhaga Book 18 connctor
Output	Working Mode	0-10V DC
	Wiring	By Zhaga Book 18 connector
Dim Interface	0-10V Dimming	< 50mA (Non-constant source)
Sensor Parameters	Operating Frequency	5.8 GHz ±75 MHz, ISM Band.
	Transmitting power	1mW Max.
	Hold time	5S/30S/1min/3min/5min/10min/20min/30min
	Stand-by DIM Level	10%(1.4-1.6V), 20%(1.9-2.1V), 30%(2.9-3.1V), 50% (4.9-5.1V)
	Stand-by Period	0s/10S/1min/3min/5min/10min/30min/+∞
	Detection Area	25%/50%/75%/100%
	Daylight Sensor	Daylight threshold: 5lux/15Lux/30Lux/50Lux/100lux/150lux/Disable Daylight priority: ON/OFF value (5lux/15Lux/30Lux/50Lux)/150Lux 100Lux/200Lux 150Lux/300Lux
	Detecting Radius	See detection pattern
Mounting Height	15m Max	

Shenzhen Merrytek Technology Co.,Ltd

Add: No.17th Building, Dianda Guyuan Industrial Park, Mashantou, Matian, Guangming District, Shenzhen, China, 518106

Tel: +86 (0)755-2305 7253

Fax: +86 (0)755-2786 3012

Website: www.merrytek.com

	Detecting Angle	150°(wall mounting) 360°(ceiling mounting)
Operating Environment	Operating Temperature	-35°C...+70°C
	Storage Temperature	Temperature: -40°C...+80°C; Humidity: 10%-95% (non-condensing)
Certificate Standards	Safety standards	EN60669-2-1, EN60669-1
	EMC standards	EN55015, EN61000-3-2, EN61000-3-3, EN61547
	Environmental Requirement	Compliant to RoHS
	IP Rating	IP65 when mount with Zhaga Block 18 connector
	Protection Class	Class II
	Installation	External mounting,integrated mounting
	Dimension	See dimension
	Package	White paper box
	Net Weight	55g
Lifetime	5 years warranty@Ta 230V full load	
<p>Note</p> <p>1. "N/A"means not available.</p> <p>2. Detection area is effected on volume of motion object and motion speed. The detection area is tested by a 165cm height person and walking speed is 0.3m/s.</p>		

3. Function

1) On/OFF Function (stand-by period be set to "0"s)

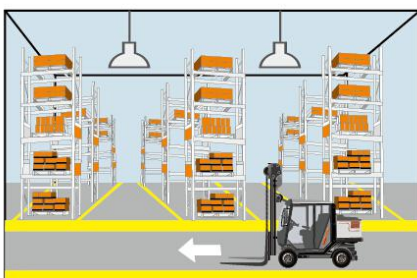

① With sufficient ambient light, the light will not be switched on even if with motion signal.

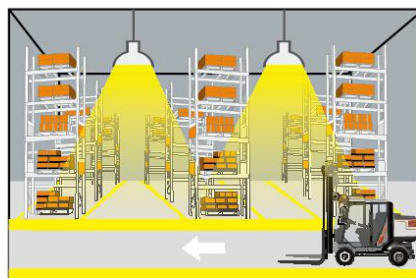

② With insufficient ambient light, the sensor switches on the light when motion is detected.

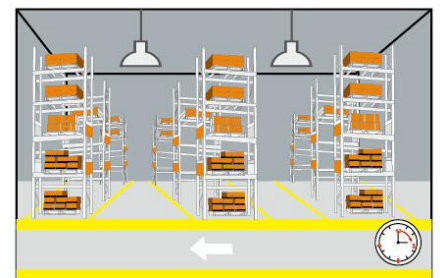

③ After elapse of hold time, the sensor switches off the light when no motion is detected.

Shenzhen Merrytek Technology Co.,Ltd

Add: No.17th Building, Dianda Guyuan Industrial Park, Mashantou, Matian, Guangming District, Shenzhen, China, 518106

Tel: +86 (0)755-2305 7253

Fax: +86 (0)755-2786 3012

Website: www.merrytek.com

2) 2-step dimming function (stand-by period be set to “+∞”)

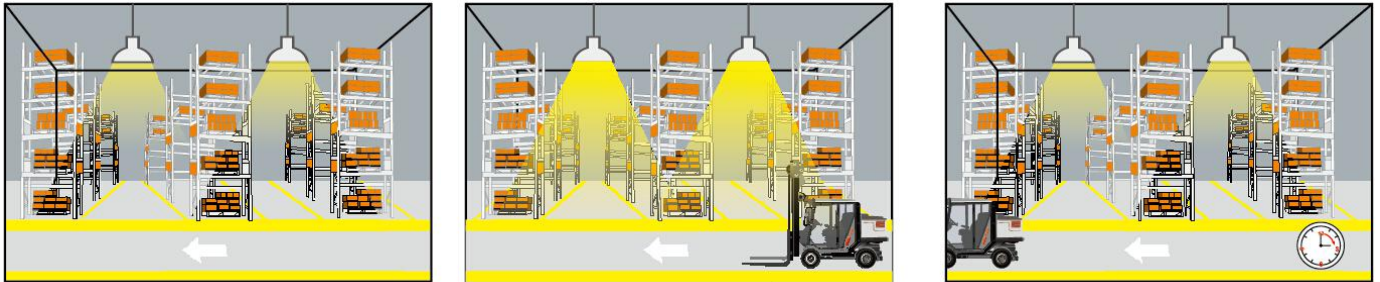

1 If there is no motion detected, the light will be remained at a low light level all the time.

2 When motion is detected, the sensor will switch on the light to 100% brightness

3 After elapse of hold time, the sensor dims the light at the present low light level if no motion is detected.

3) 3-step dimming function (stand-by period be set to “10S/1min/3min/5min/10min/30min”)



1 With sufficient ambient light, the light will not be switched on even if with motion signal.

2 With insufficient ambient light, the sensor switches on the light when motion is detected.

3 After elapse of hold time, the sensor dims the light at a low light level if no new motion is detected.

4 After elapse of standby period, the sensor switches off the light if no motion is detected in the detection zone.

4) Daylight priority (stand-by period set to +∞)

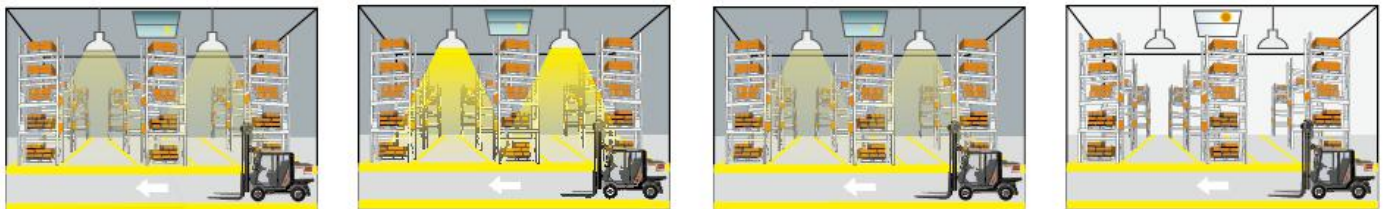

1 Lamp turns on at low light level 10% in the night.

2 Motion detected, lamp automatically lights up to 100%.

3 After hold time, the lamp gradually dims to a low light level 10% if no movement detected.

4 Lamp turns off after dawn.

4. Dimension (mm)

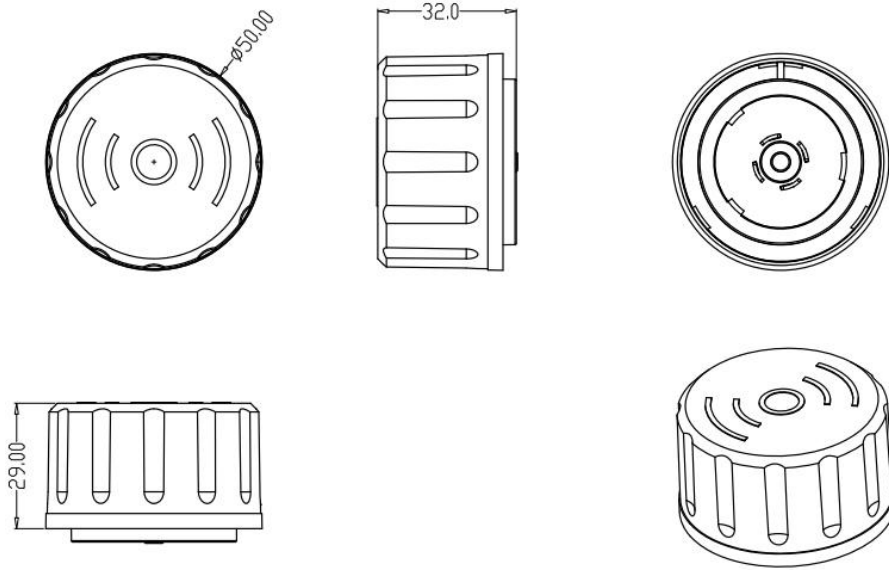

5. Wiring

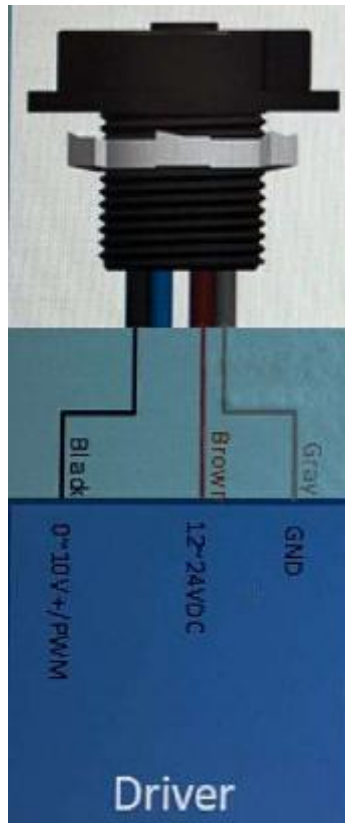

*The sensor is designed to connect one load only. Connect more than one load may damage the sensor.

6. Structure

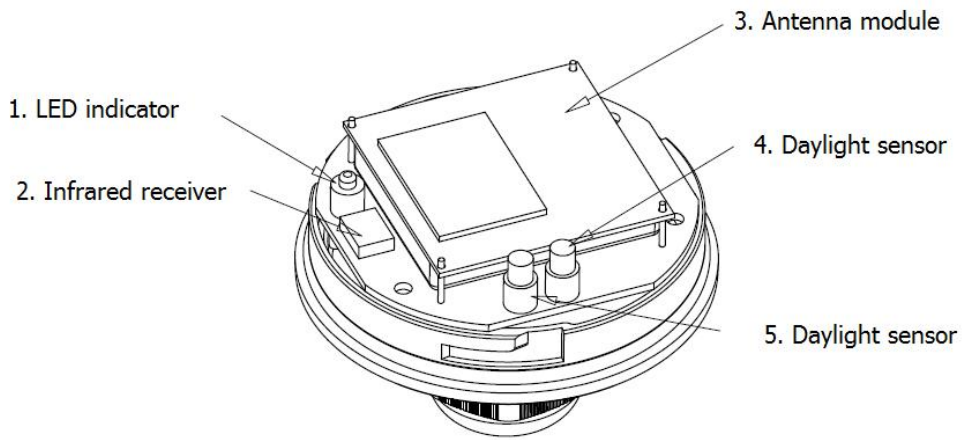

7. Installation (Match Zhaga Book 18 connector)

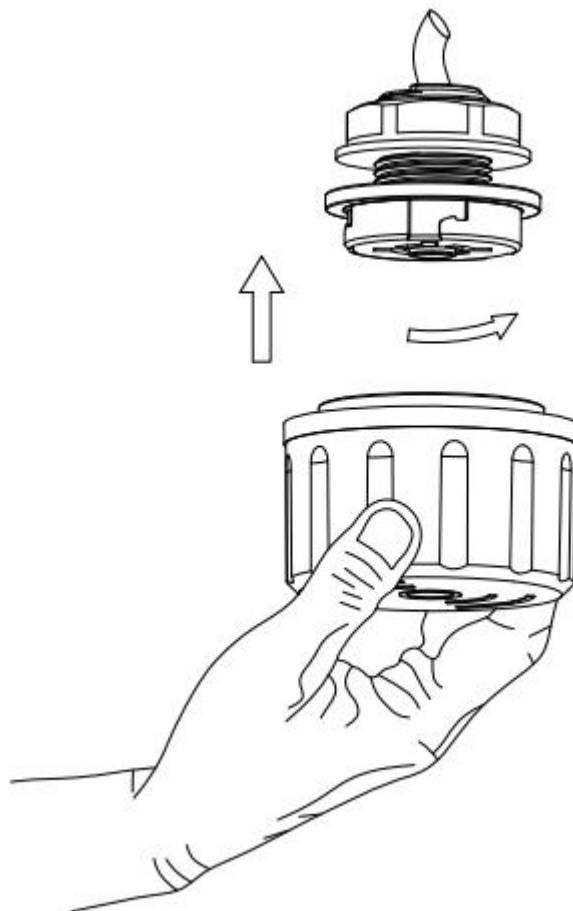

8. Radiation Pattern (Typical data)

Ceiling mounting

Ceiling mounted height: 3m
Sensitivity: 100%/75%/50%/25%

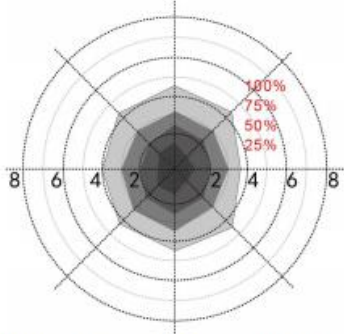

Normal moving (Speed:1m/s)

Ceiling mounted height: 10m
Sensitivity: 100%/75%/50%

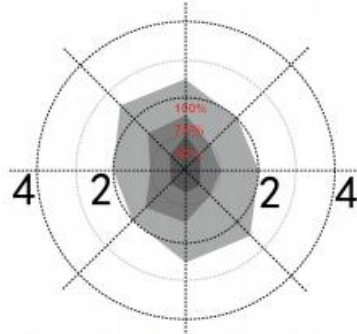

Normal moving (Speed:1m/s)

Ceiling mounted height: 15m
Sensitivity: 100%/75%/50%

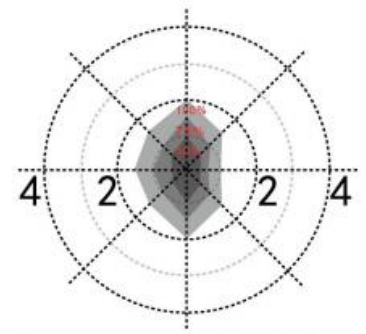

Normal moving (Speed:1m/s)

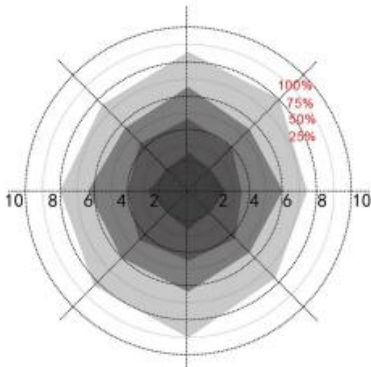

Slow moving (Speed 0.3m/s)

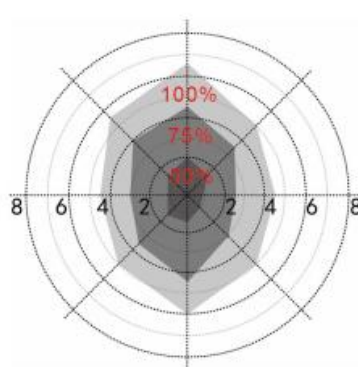

Slow moving (Speed: 0.3m/s)

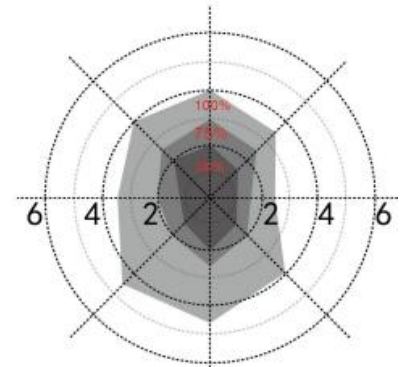

Slow moving (Speed: 0.3m/s)

*Only 100%/75%/50% detection sensitivity is workable when installed at 15m mounting height. 25% sensitivity is not able to detect motion signal.

Wall mounting

Horizon mounted height: 2m
Sensitivity: 100%/75%/50%/25%



Normal moving (Speed: 1m/s)

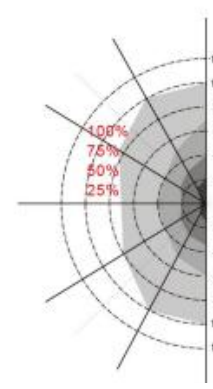

Slow moving (Speed 0.3m/s)

Shenzhen Merrytek Technology Co.,Ltd

Add: No.17th Building, Dianda Guyuan Industrial Park, Mashantou, Matian, Guangming District, Shenzhen, China, 518106

Tel: +86 (0)755-2305 7253

Fax: +86 (0)755-2786 3012

Website: www.merrytek.com

9. Remote Control

Remote Control Setting	Button	Remarks																												
		Press the "ON/OFF" button, the light goes to constant on/off mode, sensor is disabled. Press "Reset" "Auto mode" button to quit from this mode and the sensor starts to work. No memory for ON-OFF setting after power off. Sensor mode will auto recover after restart power supply.																												
		Press "Reset" button, all parameters are same as setting of DIP switch or factory settings.																												
		Press "Sensor motion" button, the light quits from the constant on/ off mode, and the sensor starts to work (The latest setting stays in validity)																												
		Press "DIM Test" button, the 1-10 V dimming works to test whether the 1-10Vdc dimming ports are connected properly. After 2s, it returns to the latest setting automatically.																												
		Long press 3s, Daylight priority mode will be switched to daylight threshold mode, lux value will go back to previous one.																												
		Short press "Dim+/Dim-" button to Set the output lumen level, each press will $\pm 2\%$ light level.																												
		Long press >3s, sensor will be switched to daylight priority mode, if preset daylight value is Disable, press DH Mode can not start daylight priority mode.																												
		<table border="1"> <thead> <tr> <th>Scene Options</th> <th>Detection Area</th> <th>Hold Time</th> <th>Stand-by period</th> <th>Stand-by dim level</th> <th>Daylight Sensor</th> <th>Induction model</th> </tr> </thead> <tbody> <tr> <td>Q1</td> <td>100%</td> <td>5min</td> <td>10min</td> <td>10%</td> <td>30Lux</td> <td>HS</td> </tr> <tr> <td>Q2</td> <td>100%</td> <td>10min</td> <td>30min</td> <td>10%</td> <td>Disable</td> <td>HS</td> </tr> <tr> <td>Q3</td> <td>100%</td> <td>20min</td> <td>30min</td> <td>10%</td> <td>Disable</td> <td>HS</td> </tr> </tbody> </table>	Scene Options	Detection Area	Hold Time	Stand-by period	Stand-by dim level	Daylight Sensor	Induction model	Q1	100%	5min	10min	10%	30Lux	HS	Q2	100%	10min	30min	10%	Disable	HS	Q3	100%	20min	30min	10%	Disable	HS
	Scene Options	Detection Area	Hold Time	Stand-by period	Stand-by dim level	Daylight Sensor	Induction model																							
	Q1	100%	5min	10min	10%	30Lux	HS																							
	Q2	100%	10min	30min	10%	Disable	HS																							
	Q3	100%	20min	30min	10%	Disable	HS																							
		Press the "TEST 2S" button can enter the test mode any time. At the mode, the sensor parameters are below: Detection Area is 100%, Hold Time is 5s, Stand-by Dim Level is 10%, Stand-by Period is 0s, daylight sensor disable. This function only for testing. Quit the mode by pressing "RESET" or any other function buttons.																												
		Press "HS" button to set the detection area to be high sensitive. Press "LS" button to set the detection area to be low sensitive. The adjustment bases on the "Detection Area" parameter you set.																												
		Daylight Sensor Set up daylight threshold: 5Lux/15Lux/30Lux/50Lux/100Lux/150Lux/ Disable																												
	Stand-by period Set up stand-by time: 0S/10S/1min/3min/5min/10min/30min/+∞																													
	Hold time Set up hold time: 5S/30S/1min/3min/5min/10min/20min/30min																													
	Stand-by dim level Set up stand-by dim level: 10%/20%/30%/50%																													
	Detection Area Set up detection area: 25%/50%/75%/100%																													
	Remote Distance Toggle button can set the remote distance of remote control and sensor.																													

Microwave sensor Factory Default setting is:
Detection area: 100%, Hold Time: 5S, Stand-by Period:
0s, Daylight Sensor: Disable,
Stand-by dim level: 10%

10. Initialization

1) On/Off function /3-step dimming function:

After power on, the sensor automatically turns on light at 100% brightness. After 10sec, it turns off the light. During the initialization, the sensor is not able to detect movement.

Shenzhen Merrytek Technology Co.,Ltd

Add: No.17th Building, Dianda Guyuan Industrial Park, Mashantou, Matian, Guangming District, Shenzhen, China, 518106

Tel: +86 (0)755-2305 7253

Fax: +86 (0)755-2786 3012

Website: www.merrytek.com

2) 2-step dimming function:

After power on, the sensor automatically turns on light at 100% brightness. After 10sec, it dims the light to a low light level (set by stand-by dim level). During the initialization, the sensor is not able to detect movement.

11. Factory Setting

Detection area: 100%, Hold Time: 5S, Stand-by Period: 0s, Stand-by dim level: 10%, Daylight Sensor: Disable

12. Instruction

- 1) The sensor should be installed by a professional electrician. Please turn off the power before installing, wiring, changing the setting of the DIP switch.
- 2) The sensor which installed in the plastic and glass lampshade will reduce the sensitivity. For every 3mm increase in thickness, the sensitivity will be reduced by 20%.
- 3) The dimming performance could be different from different 0-10v drivers.
- 4) The light sensitivity threshold is in a sunny environment, no shadow and ambient light diffuse reflection. Ambient lux level could be different in different environment, weather, climate, time-of-day and season.
- 5) The parameters of the sensor may need to be reconfigured in different installation environments. Please refer to the following instructions or contact the manufacturer.
- 6) This sensor is for indoor use only. It will affect the waterproof effect for outdoor use. Wind, rain, and moving objects around will cause false triggering.
- 7) The distance between any inductive sensors should be greater than 3m.
- 8) Do not place the sensor close to high-density objects such as metal, glass, concrete walls, etc, false triggering could happen. When the sensor is installed in a metal lamp, metal reflective surface, or a narrow enclosed environment, the microwave will be reflected repeatedly and cause false triggering. Please reduce the sensitivity or contact the manufacturer for technical support.
- 9) Please ensure that there are no moving signals around the sensor, such as fan, DC motor, sewer pipe, air outlet, etc., the sensor may generate false trigger.
- 10) You are advised to test 5 samples before mass application of sensor in a new lighting project.
- 11) Due to continuous improvement, the contents of this instruction could be changed without prior notice
- 12) A stabilized DC power supply with stable output voltage and low ripple must be used, the power supply ripple should be less than 300mV, and the load current should be greater than 25mA.

SPECIFICATION

Product Name: DC Microwave Motion Sensor(Tuya BLEUTOOTH)

Model No.: MC079D RC ZB1

Issue Date: Sept 19th, 2022

CUSTOMER APPROVED

PRODUCT DIRECTOR APPROVED	PRODUCT CHECKED	R&D CHECKED	PREPARED
			

*Please read the 11th instruction carefully before using this product, since the performance of DC-powered microwave products is closely related to the stability and characteristics of the auxiliary power supply of the LED driver.

1. Features



- 1) Patented high-gain microwave sensor, high anti-interference ability, no false trigger in metal installation site, especially designed for warehouse.
- 2) 12V DC input, for DC systems or LED power supplies with 12V DC auxiliary power output.
- 3) Using TUYA Bluetooth IOT module and supporting TUYA devices interconnects.
- 4) PWM high/low level, 0-10V dimming, 2-step dimming and 3-step dimming function.
- 5) Match Zhaga Book 18 base, plug-in design, waterproof.
- 6) Daylight priority function.
- 7) 12m maximum installation height, suitable for most warehouses.

2. Parameter

Input	Input Voltage	11-13VDC		
	Operating Current	< 50mA		
	Ripple Voltage	<100mVp-p		
Output	Dimming Signal	0-10VDC dimming signal		
Parameter	Operating Frequency	5.8 GHz ±75 MHz, ISM wave.		
	Transmitting Power	3mW Max		
	Detection Area	25%/50%/75%/100% Set by remote control or APP		
	Hold Time	5S/30S/1min/3min/5min/10min/20min/30min Set by remote control or APP		
	Stand-by Period	0s/10S/1min/3min/5min/10min/30min/+∞ Set by remote control or APP		
	Daylight Sensor	Daylight Threshold	5lux/15Lux/30Lux/50Lux/100lux/150lux/Disable	
		Daylight Priority	ON	OFF
			5lux/15Lux/30Lux/50Lux	150Lux
			100Lux	200Lux
	150lux	300Lux		
	Stand-by DIM Level	10%(1.4-1.6V) 20%(1.9-2.1V) 30%(2.9-3.1V) 50% (4.9-5.1V) Set by remote control or APP		
Detecting Area (100% sensitivity radius)	Ceiling Mounting(height: 10m): 0.3m/S ≥4m, 1m/S ≥3m; Wall Mounting(height: 2m): 0.3m/S ≥23m, 1m/S ≥14m			
Mounting Height	Typical value: 10m (12m Max)			
3db Beam Angle	82° @Xz field			
	95° @Yz field			

Wireless Module	Module Name	TUYA Bluetooth Module	
	Operating Frequency	2.4-2.484GHz	
	Transmitting Power	10dBm(max:10.5dBm)	
	Transmitting Distance	60m(visible distance)	
	Wireless Standard	Low power Bluetooth 4.2/5.0	
Environment	Operating Temperature	-25~60°C	
	Storage Temperature	-40°C...+80°C Humidity≤85% (non-condensing)	
Certificate Standards	Certificate	CE	
	Environmental Requirement	Compliant to RoHS	
	IP Rating	IP65	
Others	Wiring Method	terminal	Suitable for Zhaga Book 18 connector
	Installation	Build-in	
	Dimension	See Dimension diagram	
	Package	Clapboard + paper carton(K=A)	
	Net Weight		
	Lifetime	5 years warranty@Ta	

3. Function

1) On/OFF Function (stand-by period be set to “0”s)

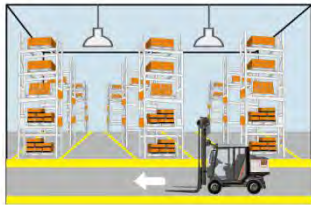

1 With sufficient ambient light, the light will not be switched on even if with motion signal.

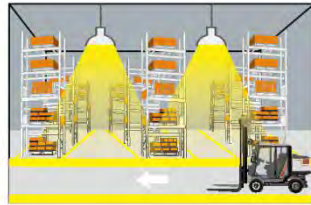

2 With insufficient ambient light, the sensor switches on the light when motion is detected.

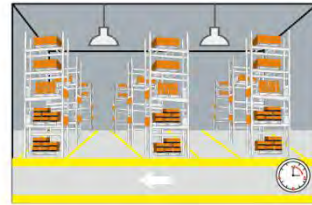

3 After elapse of hold time, the sensor switches off the light when no motion is detected.

2) 2-step dimming function (stand-by period be set to “+∞”)

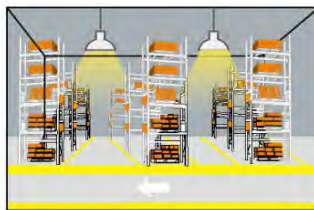

1 If there is no motion detected, the light will be remained at a low light level all the time.

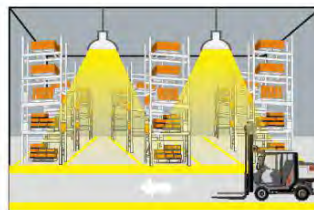

2 When motion is detected, the sensor will switch on the light to 100% brightness

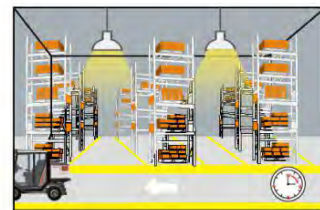

3 After elapse of hold time, the sensor dims the light at the present low light level if no motion is detected.

3) 3-step dimming function (stand-by period be set to “10S/1min/3min/5min/10min/30min”)

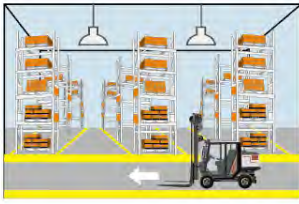

1 With sufficient ambient light, the light will not be switched on even if with motion signal.

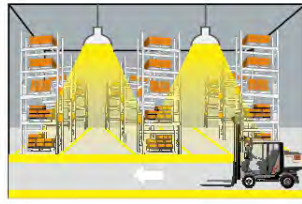

2 With insufficient ambient light, the sensor switches on the light when motion is detected.

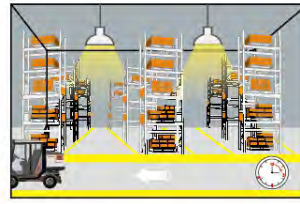

3 After elapse of hold time, the sensor dims the light at a low light level if no new motion is detected.

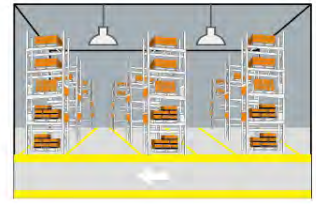

4 After elapse of standby period, the sensor switches off the light if no motion is detected in the detection zone.

4) Daylight priority ((Set Stand-by Period to “DH Mode+5lux/15Lux/30Lux/50Lux/100lux/150lux”)

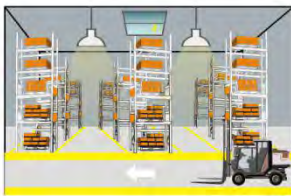

1 Lamps turn on at a low light level in the night.



2 Motion detected, lamp automatically lights up to 100%.

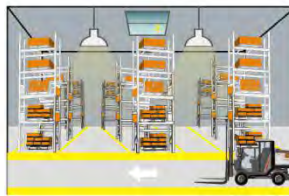

3 After hold time, the lamp gradually dims to a low light level if no movement is detected.

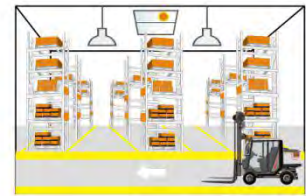

4 Lamps turn off under enough ambient light.

4. Dimension (mm)

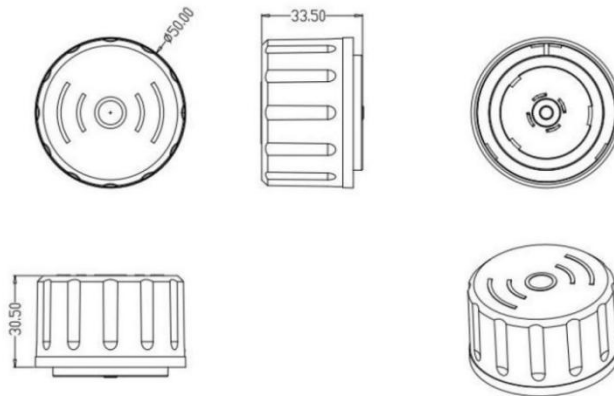

5. Wiring

*The sensor is designed for connect one load only. Connect more than one loads may damage the sensor.

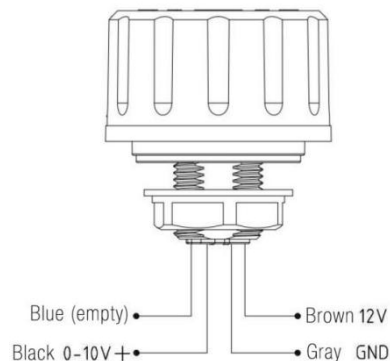

Shenzhen Merrytek Technology Co.,Ltd

Add: No.17th Building, Dianda Guyuan Industrial Park, Mashantou, Matian, Guangming District, Shenzhen, China, 518106

Tel: +86 (0)755-2305 7253

Fax: +86 (0)755-2786 3012

Website: www.merrytek.com

6. Radiation Pattern

Pending

7. APP Interface

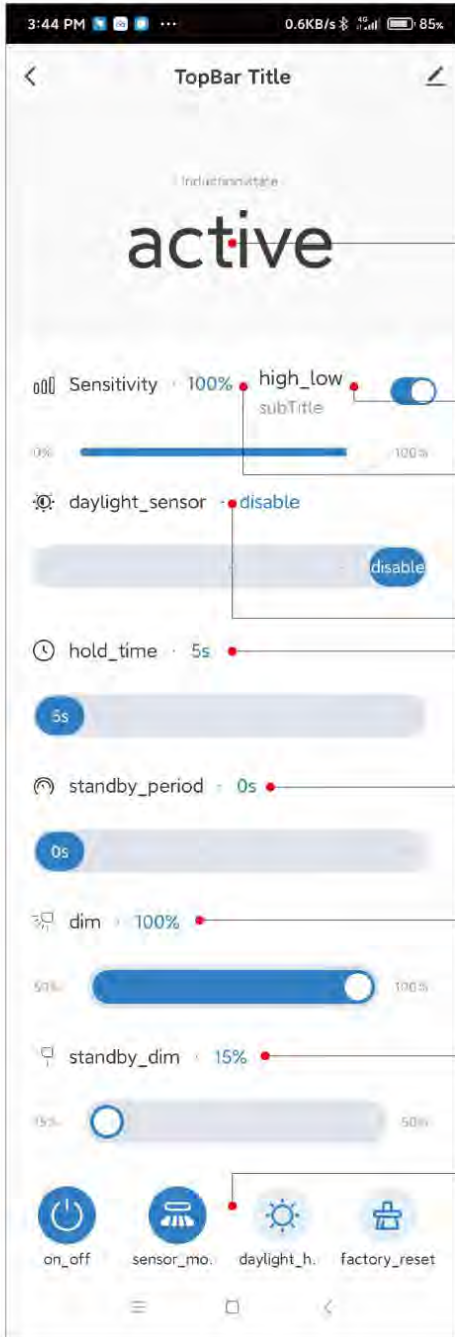

*The operation interface and the location of various parameters may be updated constantly. The picture is for reference only, take practicality as standard.

Analyzing the states of human's activity:

- 1) No-human state: there is no one in the detecting area.
- 2) Activity state: someone is moving greatly, such as walking.

Reporting the states:

- 1) Reporting immediately when no-one state changes to activity state.
- 2) "Hold time" starts after everyone leaves detecting area. Reporting no-human state after "hold time" ends.

Selecting "High/Low Sensing" can change the sensitivity in chosen detecting area

Adjusting "Sensitivity" can change the detecting sensitivity: 0%/25%/50%/75%/100%

Adjusting "daylight_sensor" can change the daylight value: 5Lux/15Lux/30Lux/50Lux/100Lux/150Lux/Disable

"Hold_time" starts after everyone leaves detecting area. Reporting no-human state after "hold_time" ends. Adjusting "hold_time" to 30s/1min/2min/3min/5min/10min/20min

Adjusting "standby_period" can change the time of low brightness: 0S/30S/1min/3min/5min/10min/30min/+∞

Adjusting "dim" can change the proportion of full brightness: 50%-100%

Adjusting "standby_dim" can change the proportion of low brightness: 15%-50%

on_off:

Clicking "on_off", light remains on or off constantly and sensing function is disabled.

sensor_motion:

Clicking "sensor_motion", constant on/off mode is changed to sensing mode.

daylight_harvesting:

Clicking "daylight_harvesting", daylight priority mode turns on.

factory_reset:

Clicking "factory_reset", all settings are changed to factory setting.

8. Initialization & Networking

- (1) When powering on for the first time, the sensor will turn the light on to 100% brightness, and the light will be turned off after 10 seconds. During initialization, movement signal will not be detected.
- (2) Download TUYA APP on the phone, install and register. Open APP and connect Bluetooth gateway.

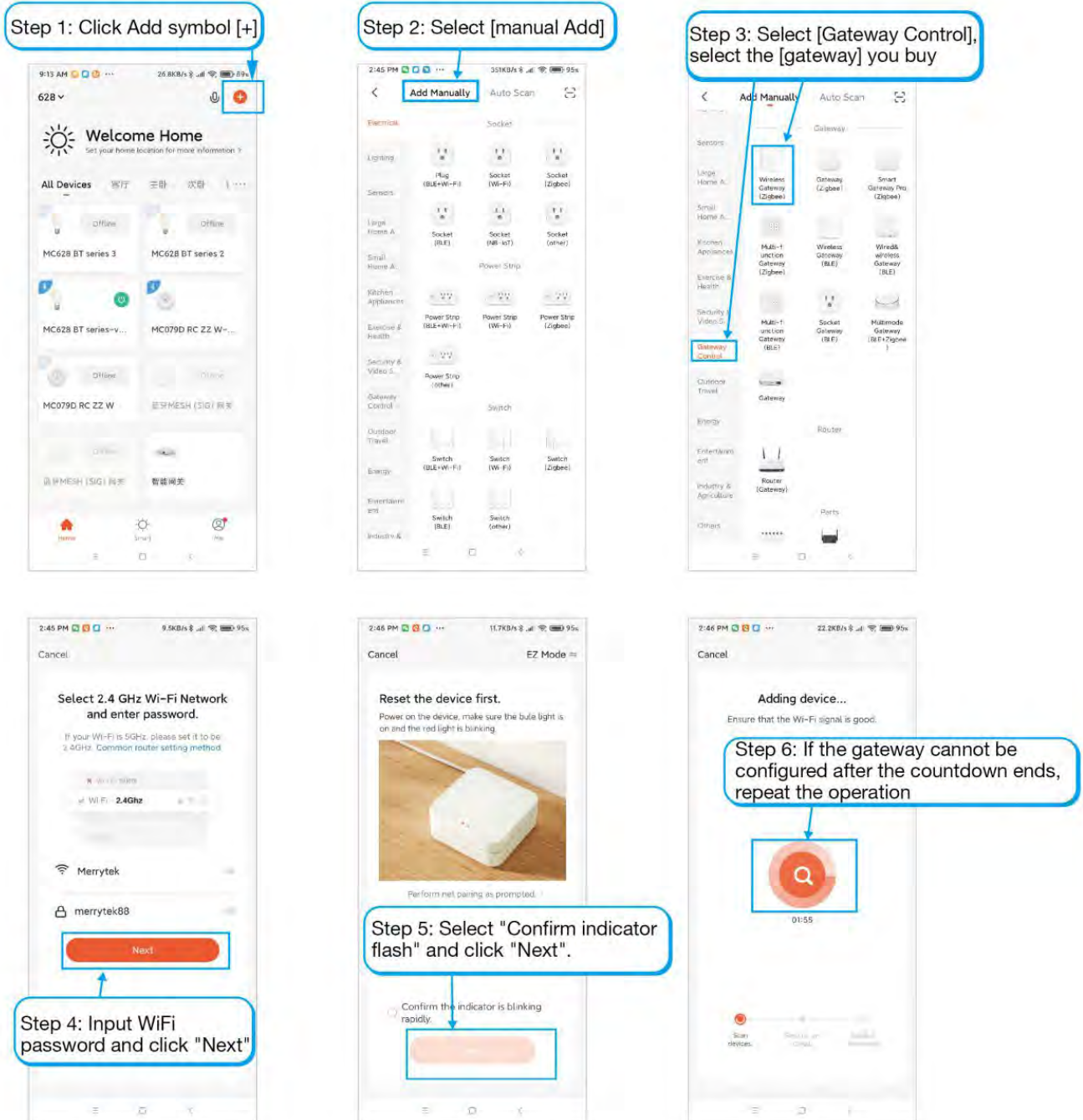

Connecting gateway automatically when first power on. The sensor will turn the light on to the preset brightness. Movement signal will not be detected. Sensor can work normally. At this moment, Bluetooth module can be paired. The sensor parameters can be set by APP after pairing successfully.

(3) If connecting to gateway is failure when power on, the sensor can be connect to gateway by pressing the “TEST2S” button on the MH10 remote control(light flashes three time). The sensor parameters can be set by APP after connecting successfully.

* Using phone to screen the below QR code to download APP.



(4) Interconnection Setting(need gateway):

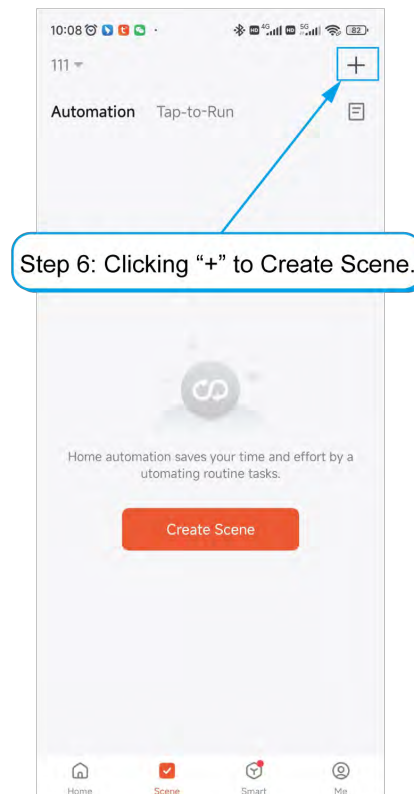
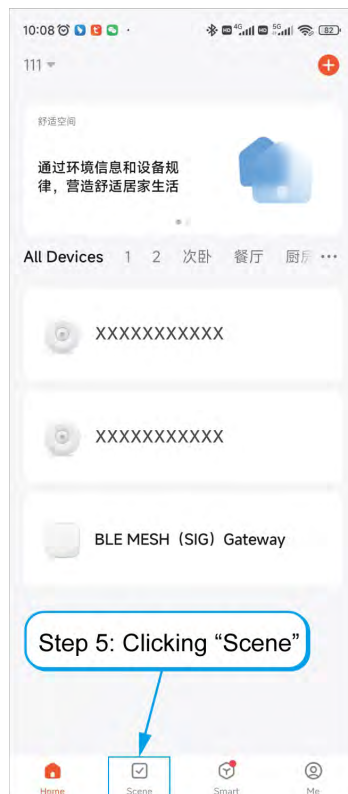
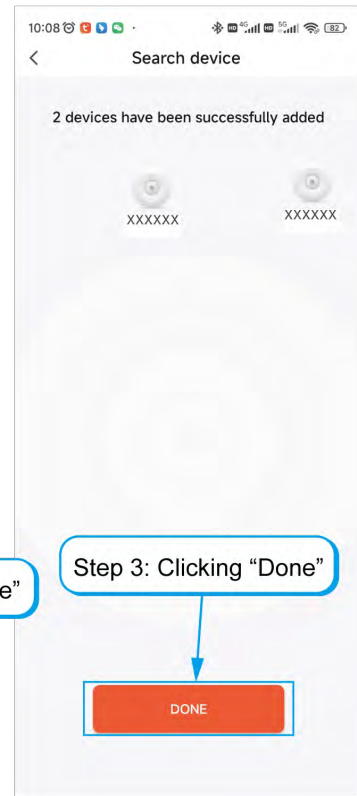
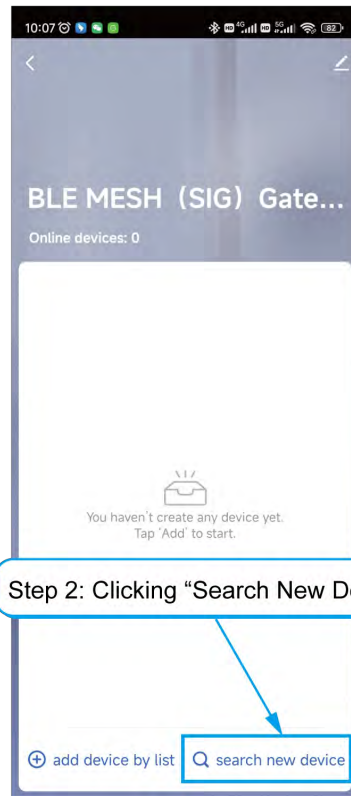

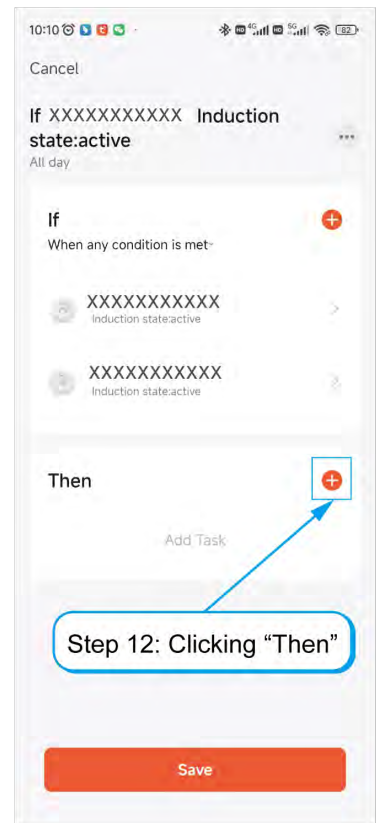
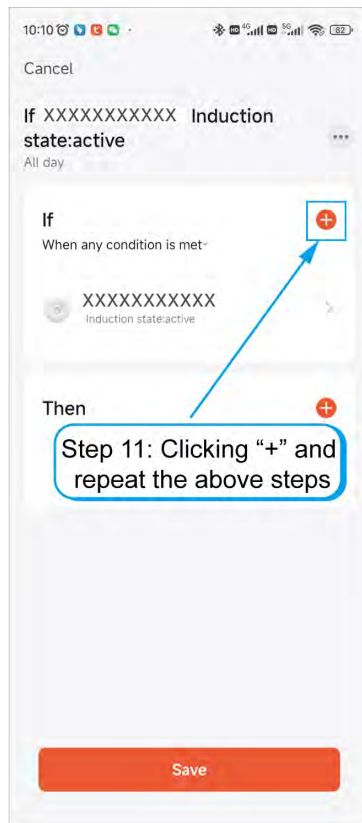
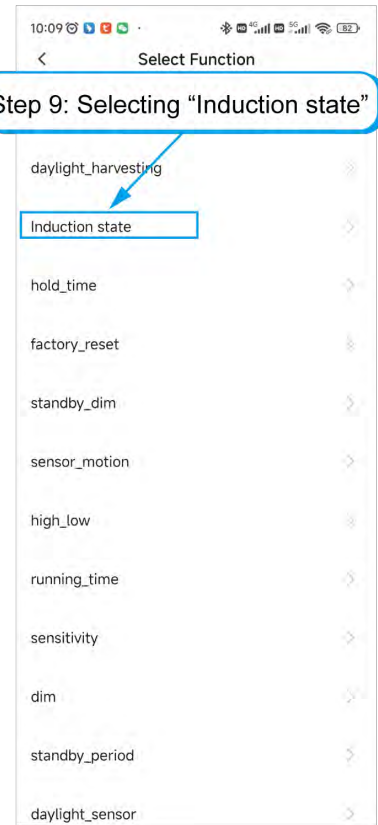
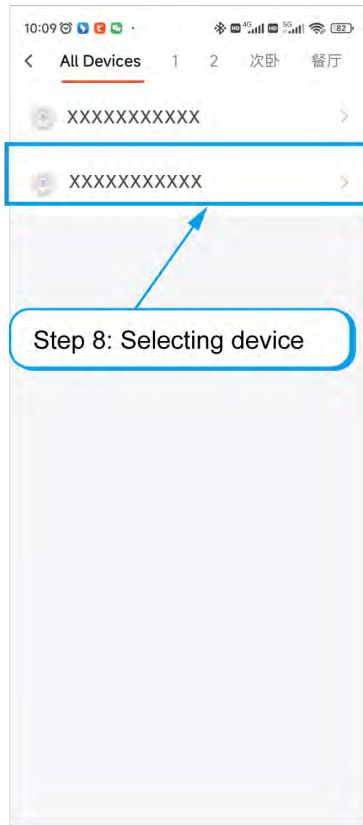
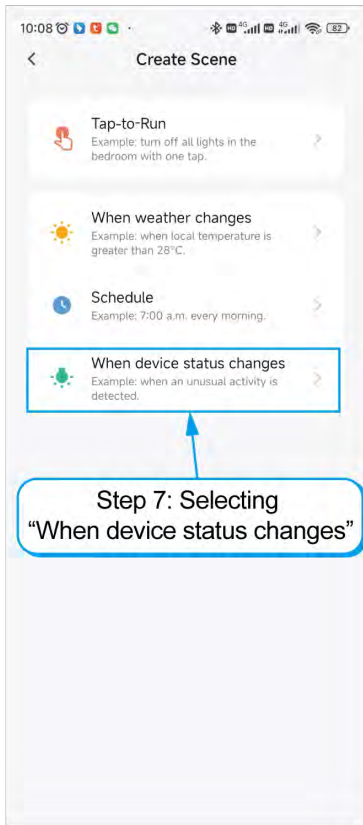

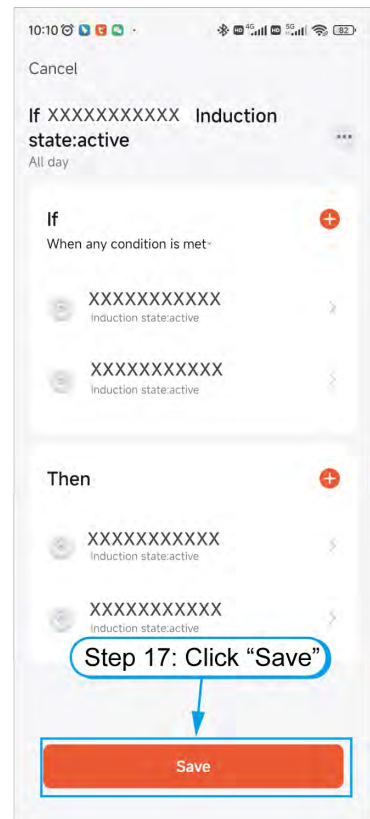
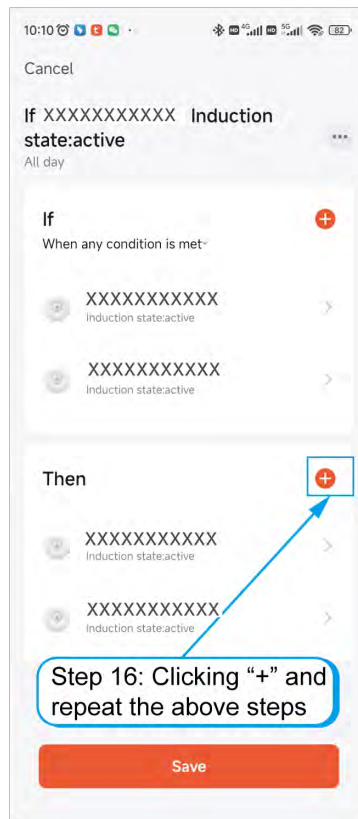
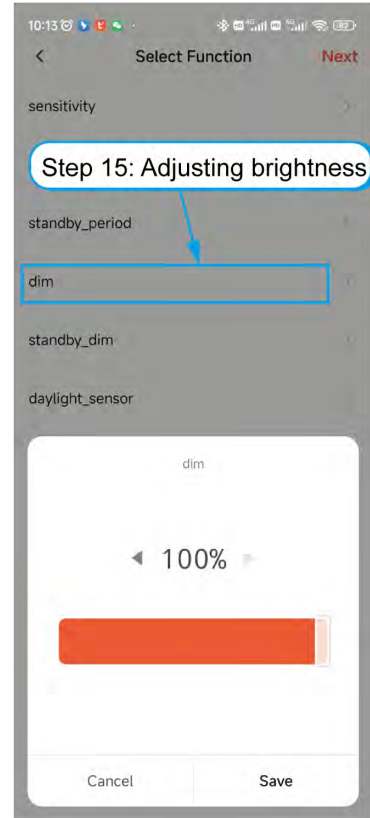

9. Factory Setting

Detection area: 100%, Hold Time: 5S, Stand-by Period: 0s, Daylight Sensor: Disable,
Stand-by dim level: 10% (factory setting can be changed as required)

10. Instruction

- (1) The sensor should be installed by a professional electrician. Please turn off the power before installing, wiring, changing the setting of the DIP switch.
- (2) Sensitivity area is related to moving speed of objects, size of moving objects, mounting height, mounting angle, working environment, reflecting materials and etc. Given detecting area is typical value that was measured by 165cm high testers in an indoor open environment.
- (3) This product is suitable for ceiling mounting. If wall mounting, the detecting area will enlarge which makes microwave penetrate wall or light not turn off. Please lower the sensitivity area or contact the manufacturer for technical support. Daylight threshold is in a sunny environment with no shadows and ambient light diffuse reflection conditions. The values illumination detected by sensor may vary in different environment, at different times, in different seasons, and in different climates.
- (4) The parameters of the sensor may need to be connect again in different installation environments. Please refer to the following instructions or contact the manufacturer.
- (5) This sensor is for indoor use only. It will affect the waterproof effect for outdoor use. Wind, rain, and moving objects around will cause false triggering.
- (6) The mounting height is no more than 12. The best height is 10 meters. The distance between any sensors should be greater than 3m.
- (7) When the sensor is installed in a metal lamp, metal reflective surface, or a narrow enclosed object, the microwave will be reflected repeatedly and cause false triggering. Please reduce the sensitivity or contact the manufacturer for technical support.
- (8) Please ensure that there are no moving signals around the sensor, such as fan, DC motor, sewer pipe, air outlet and so on. Otherwise the sensor may generate false trigger.
- (9) Microwaves cannot penetrate metal. Do not place the sensor in a closed metal lamp or a half-closed metal lamp and no metal or glass cover above sensor.
- (10) Different 0-10V driver, different low brightness.
- (11) Require stabilized DC power supply with stable output voltage and low ripple, the power supply ripple should be less than 100mV, and the load current should be greater than 60mA.
- (12) Due to continuous improvement, the contents of this instruction could be changed without prior notice.