

Project:	
Type:	
Catalog # :	

FME Lighting | 877 - 234 - 8460 | info@fmelighting.com



SPECIFICATIONS

VOLTAGE	AC100-277V/AC100-347V/AC 277-480V (50/60Hz)
WATTAGE	80W, 100W, 150W, 200W
COLOR TEMP	3000K, 4000K, 5000K and 5700K Kelvin
AMBIENT TEMP	-40° F (-40° C) to 113° F (45° C)
HOUSING	• Stainless Steel & Die Cast Aluminum • No Exposed Screws, Corrosion Resistant, Powder Coat White Finish
LENS	PC or Glass
BEAM ANGLE	115° / Wide <i>See Lumens & Optic Chart</i>
OPTICS	• Ra80 for general light efficacy • Ra70 for high light efficacy
LED	LUXEON 2835C LEDs
DRIVER	SOSEN SS-120NH-130BH
SENSORS	Microwave Sensor <i>See Sensor Info on Page 2 for More.</i>
PROTECTION	• IP69K/IP66, UL Wet Locations • 500hrs Salt Fog Rated, NSF (PC Lens Only)
DIMMING	0-10V Dimmable
WARRANTY	5 Year Limited Warranty

DIMENSIONS

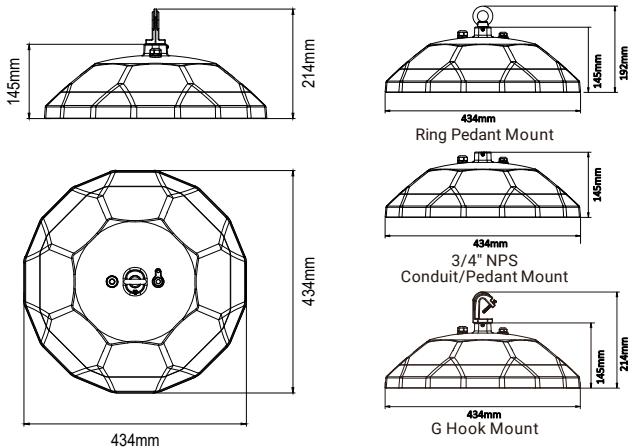

RATINGS

- UL 1598
 - CSA C22.2 No. 250.0
 - IP69K/IP66
 - DLC Premium (Contact Factory for Information)
 - NSF Rated*
- *With PC Lens*

KEY FEATURES

- **Brightness and Efficiency:** Offers up to 39,000 lumens with a standard efficiency of 150 lumens per watt going up to 190 lumens per watt, suitable for high-intensity environments.
- **Thermal Management and Installation:** Features an integrated heat sink for optimal thermal management and includes a 5-foot power cord, 1-foot dimming cord and 1-foot safety lanyard for installation flexibility. *See Fig 2*
- **Certifications and Compliance:** NSF certified, IP66 and IP69K rated for durability in harsh environments; also complies with cULus and DLC standards for safety and efficiency. Power coat corrosion resistant finish, providing 500hrs of salt fog rating.
- **Industrial Applications:** Ideal for food processing, poultry processing and, commercial kitchens.



FIG 2 | WIRE PLACEMENT ON G-HOOK



Sensor
Microwave sensor
(Installed in the middle of Lens)
• Maximum sensing height through PC lens: 10M/33FT

LUMENS & OPTICS

See Page 3 for Details

ORDERING INFORMATION

ORDERING GUIDE

Series	Wattage	CCT	Voltage	Mounting	Sensor	Housing Color	Efficacy	Lens
FGH	A = 80W B = 100W D = 150W F = 200W	30K = 3000K 40K = 4000K 50K = 5000K 57K = 5700K	LV = 100-277VAC MV = 100-347VAC HV = 277-480VAC	G = G Hook Mount (Standard) PM = O Ring Pendant CDM = Pendant Mounted (Conduit) <i>*More Separate Purchase Mounting Options on Page 2.</i>	S = with Sensor N = without Sensor	W = White Standard CC = Custom Color (Contact Factory)	5 = 150lm/w (Standard) 9 = 190lm/w	G = Glass Lens P = PC Lens (NSF SAFE)

See Page 4 & 5 for Installation Instructions.

ACCESSORIES

ORDERING GUIDE CONT.

SENSORS

Factory Installation ONLY

	<p>FGH-S Built-in Microwave Sensor for FGH Fixtures <i>Installed in the middle of Lens</i></p> <ul style="list-style-type: none"> • Maximum sensing height through Glass lens: 8M/26FT • Maximum sensing height through PC lens: 10M/33FT
---	--



Field Installation / Field-Use ONLY
(purchased separately)

	<p>FGH-RC Remote Control</p>
--	---

EMERGENCY BATTERY BACKUP

Factory Installation OR Field Installation

(Field Installation purchased separately)

	<p>FGH-25EB Emergency Battery Backup EMUFO-25170-YY II -25W/90min, for FGH Series 80W to 150W Models, at AC120-277/347V</p>		<p>FGH-40EB Emergency Battery Backup EMUFO-40170-YY II -40W/90min, for FGH Series 200W Models, at AC120-277/347V</p>
	<p>FGH-40EB Emergency Battery Backup EMUFO-40500DI-YY -40W/90min, for FGH Series 80W to 200W Models, at AC277-480V</p>		

MOUNTS & BRACKETS

Field Installation

(Field Installation purchased separately)

	<p>FGH-G G Hook for FGH Series</p>		<p>FGH-ETM12 External Threads M12 to Internal Threads 3/4"NPS Adapter Wiring for FGH Fixtures</p>
	<p>FGH-JBK Junction Box Kit -3/4"NPS to Internal Threads 3/4" NPS Junction Box, Without Cable Waterproof Connector, White for FGH Fixtures</p>		

REFLECTOR

Field-Installation

(Field Installation purchased separately)

	<p>FGH-PCR Polycarbonate Reflector -100 degree for FGH Series</p>
---	--

PERFORMANCE DATA

Lumen values are based on 120VAC input product configuration, contact for performance data on any configurations not shown here.

General Efficacy

Model	Nominal CCT	Lumens	Watts	LPW	CRI
FGH-8-A	3000K	11,200	80W	140	>80
	4000K	11,360		142	
	5000K	11,680		146	
	5700K	12,000		150	
FGH-10-A	3000K	14,000	100W	140	>80
	4000K	14,200		142	
	5000K	14,600		146	
	5700K	15,000		150	
FGH-15-A	3000K	21,000	150W	140	>80
	4000K	21,300		142	
	5000K	21,900		146	
	5700K	22,500		150	
FGH-20-A	3000K	28,000	200W	140	>80
	4000K	28,400		142	
	5000K	29,200		146	
	5700K	30,000		150	

High Efficacy

Model	Nominal CCT	Lumens	Watts	LPW	CRI
FGH-8-B	3000K	14,000	80W	175	>70
	4000K	14,400		180	
	5000K	14,800		185	
	5700K	15,200		190	
FGH-10-B	3000K	17,500	100W	175	>70
	4000K	18,000		180	
	5000K	18,500		185	
	5700K	19,000		190	
FGH-15-B	3000K	26,250	150W	175	>70
	4000K	27,000		180	
	5000K	27,750		185	
	5700K	28,500		190	
FGH-20-B	3000K	35,000	200W	175	>70
	4000K	36,000		180	
	5000K	37,000		185	
	5700K	38,000		190	

ELECTRICAL DATA

Model Series	Wattage(W)	Current (A)					
		Input Voltage (V)					
		120	208	240	277	347	480
FGH-8	80	0.74	0.43	0.37	0.32	0.26	0.19
FGH-10	100	0.93	0.53	0.46	0.40	0.32	0.23
FGH-15	150	1.39	0.80	0.69	0.60	0.48	0.35
FGH-20	200	1.85	1.07	0.93	0.80	0.64	0.46

INSTALLATION WARNINGS

Upon Receipt:

- Thoroughly inspect for any freight damage upon receipt. All damage should be reported to the delivery carrier.
- Compare the catalog description listed on the packing slip with the fixture label on the inside of the housing to be sure you have received the correct merchandise.

Read and Follow These Safety Instructions!

- To reduce the risk of death, personal injury or property damage from fire, electric shock, falling parts, cuts/abrasions, and other hazards please read all warnings and instructions included with and on the fixture box and all fixture labels.
- Before installing, servicing, or performing routine maintenance on this equipment, follow these general precautions.
- **Commercial Installation:** service and maintenance of luminaries should be performed by a qualified licensed electrician.
- **For Residential installation:** If you are unsure about the installation or maintenance of the luminaries, consult a qualified licensed electrician and check your local electrical code.
- Maintenance of the luminaries should be performed by person(s) familiar with the luminaries' construction and operation and any hazards involved. Regular fixture maintenance programs are recommended.
- This fixture is intended to be connected to a properly installed and grounded UL listed junction box.
- It will occasionally be necessary to clean the outside of the reflectors/lens. Reflectors/lens should be washed in a solution of warm water and any mild, nonabrasive household detergent, rinsed with clean water and wiped dry. Should optical assembly become dirty on the inside, wipe reflectors/lens and clean in above manner, replacing damaged gaskets as necessary.
- **DO NOT INSTALL DAMAGED PRODUCT!** This luminary has been properly packed so that no parts should have been damaged during transit. Inspect all items to confirm.
- Any part damaged or broken during or after assembly should be replaced.

These instructions do not purport to cover all details or variations in equipment nor to provide every possible contingency to meet in connection with installation, operation, or maintenance.

Should further information be desired or should particular problems arise which are not covered sufficiently for the purchaser's/owner's purposes, this matter should be referred to manufacturer.

Warning: Risk of Electric Shock

- Disconnect or turn off power before installation or servicing.
- Verify that supply voltage is correct by comparing it with the luminary label information.
- Make all electrical and grounded connections in accordance with the National Electrical Code (NEC) and any applicable local code requirements.
- All wiring connections should be capped with UL approved wire connectors.

Caution: Risk of Fire

- Keep combustible and other materials that can burn, away from lamp/lens.
- Do not operate in close proximity to persons, combustible materials, or substances affected by heat.

Warning: Risk of Burn

- Allow lamp/fixture to cool before handling. Do not touch enclosure, lens or light source.
- Follow all manufacturer's warnings, recommendations and restrictions including but not limited to: driver type, mounting locations/methods, replacement and recycling.
- Use only lamps that comply with ANSI standards.

Caution: Risk of Injury

- Wear gloves and safety glasses at all times when removing luminary from carton, installing, servicing or performing maintenance.
- Avoid direct eye exposure to the light source while it is on.

Caution: Risk of Product Damage

- Never connect components under load.
- Do not mount or support these fixtures in a manner that can cut the outer jacket or damaged wire insulation.
- Unless individual product specifications deem otherwise: Never connect an LED product directly to dimmer packs, occupancy sensors, timing devices, or other control devices. LED fixtures must be powered directly off a switched circuit.
- Unless individual product specifications deem otherwise: Do not restrict fixture ventilation. Allow for some volume of air space around the fixture. Avoid covering LED fixtures with insulation, foam, or other material that will prevent convection or cooling.
- Unless individual product specifications deem otherwise: Do not exceed fixtures' maximum ambient temperature.
- Only use the fixture in its intended location.
- LED products are polarity sensitive. Ensure proper polarity before installation.
- Electrostatic Discharge (ESD): ESD can damage LED fixtures. Personal grounding equipment must be worn during all installation or servicing of the unit.
- Do not touch individual electrical components as this can cause ESD, shorten lamp life, or alter performance.
- Some components inside the fixture may not be serviceable.
 - If your unit requires service, stop using the unit immediately and contact an approved representative for assistance.
- Changes or modifications not expressly manufactured by manufacturer will void the product warranty.

Always read the fixtures' complete installation instructions prior to installation for any additional fixture specific warnings.

INSTALLATION INSTRUCTIONS

Hook Installation

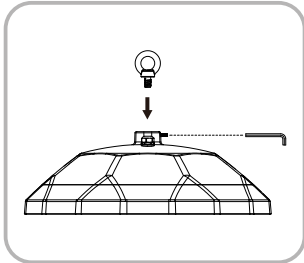

1. Fix the ring to the lamp (rotate clockwise), tighten the screw

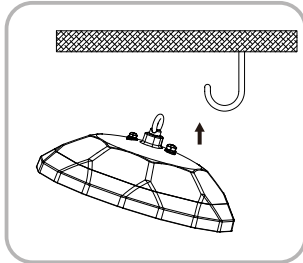

2. Put the ring into the mounting hook

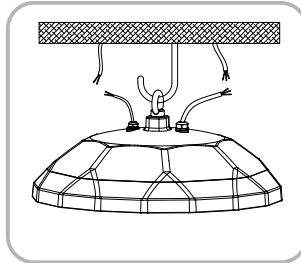

3. Wired as required under safety protection

PACKAGE

1. FGH UFO High Bay
2. Installation Instruction.

TROUBLESHOOTING

1. Check that the line voltage at the fixture is correct. Refer to wiring directions.
2. Is the fixture grounded properly.
3. Be sure the photocell, if used, is functioning properly.

Conduit Pendant Installation

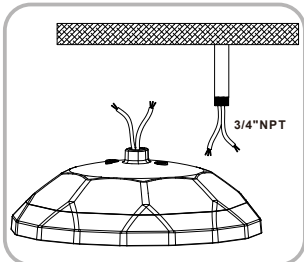

1. Wired as required under safety protection

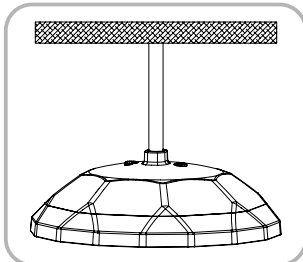

2. Rotate the lamp to the mounting pipe (rotate clockwise)

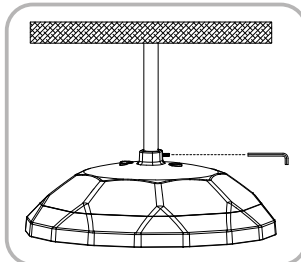

3. tighten the screw

Conduit with Junction Box Installation

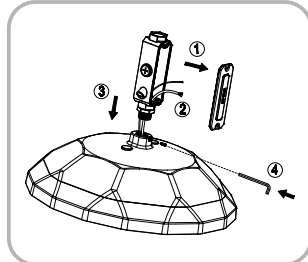

1. Remove the cover, thread the wire into the junction box, and tighten the terminal box and set screw

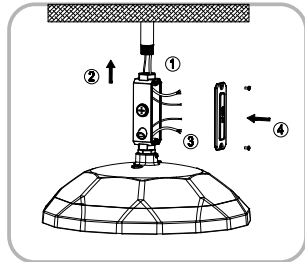

2. Thread the wire into the junction box, install the junction box on the pipe, wire according to the requirements, take protective measures, and lock the cover

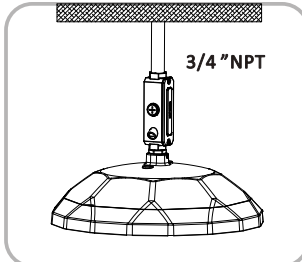

3. Installation effect

Wiring Diagram

