

Project:	
Type:	
Catalog #:	

FME Lighting | 877 - 234 - 8460 | info@fmelighting.com



SPECIFICATIONS

VOLTAGE	120 - 277 VAC
WATTAGE W/O BATTERY	80W / 100W / 120W / 135W / 150W / 165W / 180W / 200W
WATTAGE W/ BATTERY	140W / 155W / 170W
COLOR TEMP	3000 / 5000 Kelvin
HOUSING	Aluminum Alloy
COLOR	Gray
LENS	Tempered Glass
LIFETIME	60,000 hrs L70
CRI	≥ 80 (3000K) / ≥70 (5000K)
BEAM ANGLES	X-116° / Y-114°
POWER FACTOR	cos ≥ 0.9
PROTECTION	IP67 / NEMA 6
ENTRANCE THREAD	1 X 3/4
DIMMING	None Dimming
WARRANTY	5 Year Limited Warranty

CERTIFICATIONS / RATINGS

- Class I, Div 1, Groups B, C, D
- UL 844
- UL 1598 Luminaries
- CSA C22.2 No. 137
- -20C ~ +40C, T5 Rated
- -4F ~ 104F

KEY FEATURES & BENEFITS

- Up to 120 minute integrated emergency battery backup available.
- Options of a 2 or 3 tempered glass window design.
- Durable aluminum alloy enclosure.
- High-level protection with IP67 and NEMA 6 ratings, ideal for hazardous locations.

DIMENSIONS & WEIGHT

Configuration	lbs
2 Windows	25.4lb
3 Windows	33.7lb
W/ EM Battery	37.7lb

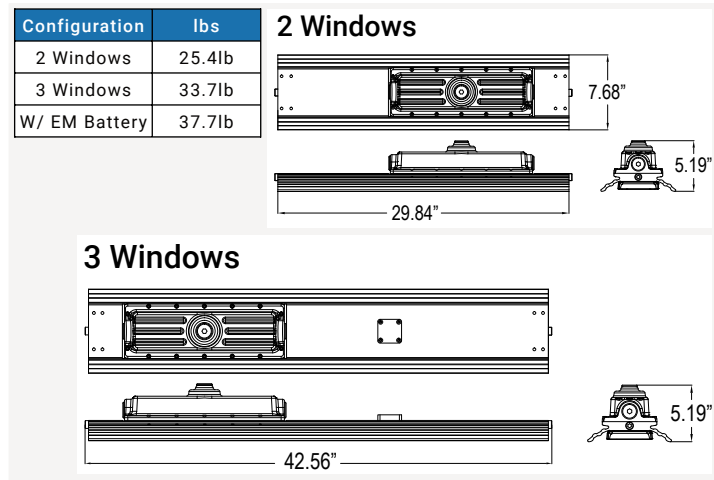

BATTERY SPECIFICATIONS

Charging Time	EM Mode Illumination Time	EM Mode Output Watts
120 min	120 min	60W (Single Window Illuminates)

LUMENS & OPTICS

Kelvin	80W	100W
3000K	10,400	13,000
5000K	11,200	14,000
	120W	135W
3000K	15,600	17,550
5000K	16,800	18,900
	150W	165W
3000K	19,500	21,450
5000K	21,000	23,100
	180W	200W
3000K	23,400	26,000
5000K	25,200	28,000

Polar Luminous & Intensity Distribution

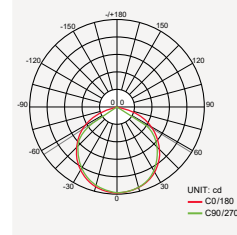

Luminous & Intensity Distribution Diagram

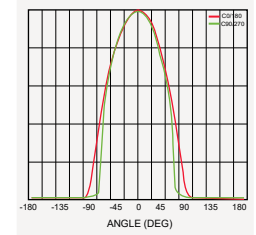

ORDERING INFORMATION

ORDERING GUIDE

Series	Watts/Windows/Battery	Voltage	CCT	Mounting	Accessory
CES-2	A2N = 80W - 2 Windows - No battery B2N = 100W - 2 Windows - No battery C2N = 120W - 2 Windows - No battery D3N = 135W - 3 Windows - No battery E3N = 150W - 3 Windows - No battery F3N = 165W - 3 Windows - No battery G3N = 180W - 3 Windows - No battery H3N = 200W - 3 Windows - No battery I3B = 140W - 3 Windows - 120 min battery J3B = 155W - 3 Windows - 120 min battery K3B = 140W - 3 Windows - 120 min battery	LV1 = 120 VAC LV2 = 277 VAC	S = 3000K C = 5000K	CM = Ceiling Mount HG = Hanging Mount WM = Wall Mount	EM = Emergency Battery Backup* JB = Junction Box

*(At loss of power the battery will continue to work for 1.5 hours or more)

MOUNTING OPTIONS

CM- Ceiling Mount

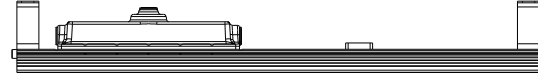
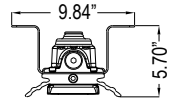
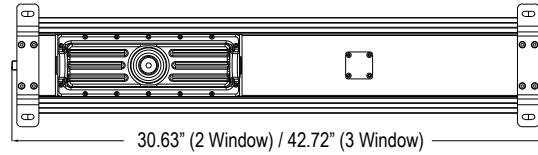
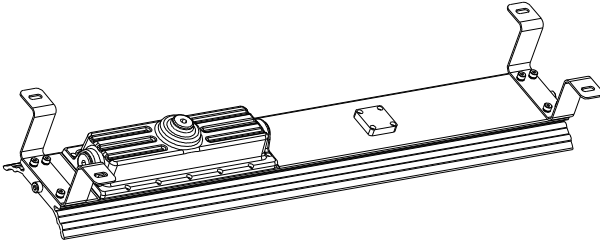

HG- Hanging Mount

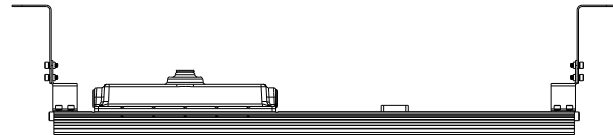
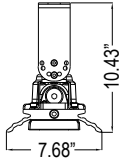
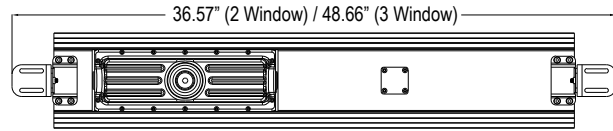
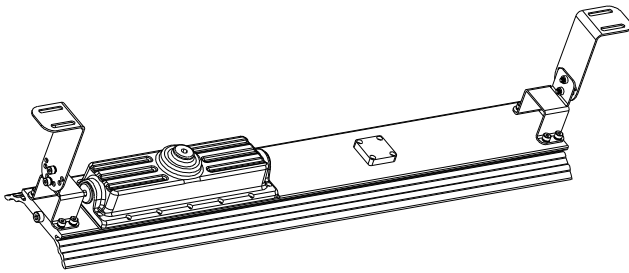

WM- Wall Mount

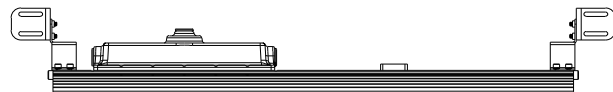
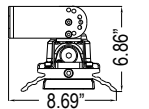
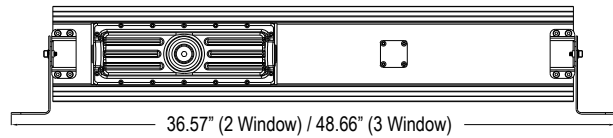
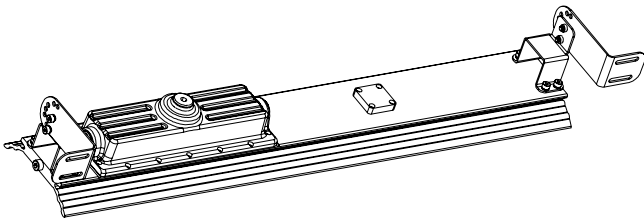



KEY FEATURES AND BENEFITS

The OPEB series junction box intend to be used or explosive atmospheres. For general wiring in hazardous locations. Copper free aluminum enclosure.

- Ex d type flameproof enclosure.
- Four types of enclosures available.
- The degree of protection is IP66.

SPECIFICATIONS

Model	Terminal Spec
OPEB	2.5mm ² / 24A
	2.5mm ² / 24A
	4mm ² / 27A

Number of Terminal Block	Cable Entry Spec	Cable Entry Amount
Max. 4	¾" NPT / M25x1.5	Max.5

- Certification For OPEB Series Junction Box**
- Class I, Division 1, Groups A, B, C and D
 - Class I, Division 2, Groups A, B, C and D
 - Class II, Division 1, Groups E, F and G
 - Class II, Division 2, Groups F and G
 - Class III

Rated Voltage Max.800VAC
Rated Current 24A, 32A, 41A

- Ambient Temperature**
- Type A, B, C, D, E, F: Threaded joints
 - Type KB1: Flanged and threaded joints

DIMENSIONS

