

LRB SERIES

NSF RATED LINEAR



Project:	
Type:	
Catalog #:	

L70
25°C → 72,000 Hours



The LRB is designed for the harsh environments found in food processing, heavy industrial manufacturing, warehouse, and distribution facilities. The IP66 waterproof design is an ideal task light to retrofit existing linear fluorescent as well as HID high-bay fixtures.

FOOD & BEVERAGE PROCESSING

MANUFACTURING & DISTRIBUTION

LIVESTOCK FARMING

PERFORMANCE

Lumen Output	7,500-20,000 lumens
Lifespan	L70> 72,000 Hours
Ambient Temperature	-4°F to 122°F (-20°C to 50°C)
Warranty	5 Years
Efficacy	Up to 130 LPW
Power Washing	Up to 1600 PSI

ELECTRICAL

Operating Voltage	120-277V
Input Frequency	50/60Hz
Input Wattage	4ft - 58W, 80W / 8ft - 80W, 160W
Surge Protection	2.5kV
Dimming	0-10V
Power Input	Standard 6' Yellow Cable (5-conductor wire to pigtails)

CONSTRUCTION

IP Rating	IP66
IK Rating	IK10
Weight	4ft - 6.2lbs (2.8kg) / 8ft - 10.8lbs (4.9kg)
Dimensions	4ft - 49.41"L x 3.15"D / 8ft - 97.42"L x 3.15"D
Housing	Die Casted Aluminum Alloy
Finish	Heat Dissipating Powder Coat
Lens	Shatterproof Polycarbonate

OPTICAL

CRI	≥80 (90 Optional)
CCT	4000K, 5000K
Beam Angle	120°

Ordering Information

Model	Length	Wattage		Voltage	CCT
		4 Foot	8 Foot		
LRB Linear Task Light	4F=4 Foot 8F=8 Foot	58=58W 80=80W	80=80W 160=160W	LV=120-277V	4K=4000K 5K=5000K

Options & Accessories

Accessories (Order Separately)

Plugs	Description
WM	Wall Mount Bracket
P3	3pin Mini Connector Male Plug
P5	5pin Mini Connector Male Plug
5P	120v Plug
L6P	Locking 208/240v Plug
L7P	Locking 277v Plug
W5P	Watertite 120v Plug
W6P	Watertite Locking 208/240v Plug
W7P	Watertite Locking 277v Plug

Cordsets (Order Separately)

Order Code	Description
MIN-3FP-6	3 Conductor Female 6' Cable to Pigtails
MIN-5FP-6	5 conductor Female 6' Cable to pigtails
MIN-3MFP-6	3 conductor Female 6' Cable to Male
MIN-5MFP-6	5 Conductor Female 6' Cable to Male

LRB Characteristics

Lumen Package	Wattage		Amp Draw		Dimensions		Diameter with Ring Mount	Comparable Light Source
	120V	277V	120V	277V	Length	Diameter		
7,500 L	60	58	0.50	0.22	49.41"	3.15"	4.4"	2 Lamp T8 Vapor
10,000 L	80	78	0.68	0.30	49.41"	3.15"	4.4"	4 Lamp T8 Vapor, 2 Lamp T5 HO Vapor
10,000 L	80	78	0.68	0.30	97.42"	3.15"	4.4"	2 Lamp 8' T8 Vapor
20,000 L	160	157	1.35	0.60	97.42"	3.15"	4.4"	4 Lamp 8' T5 HO Vapor

LRB Distribution Diagram

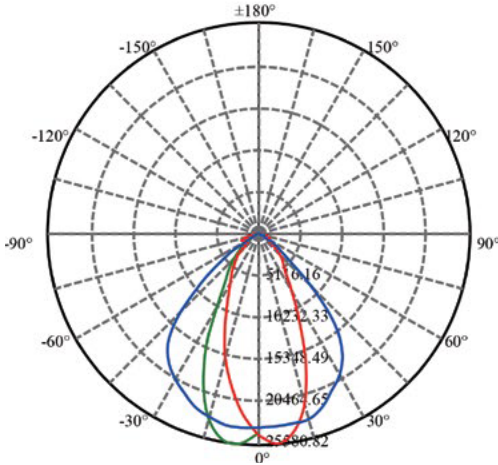

Wiring Diagram

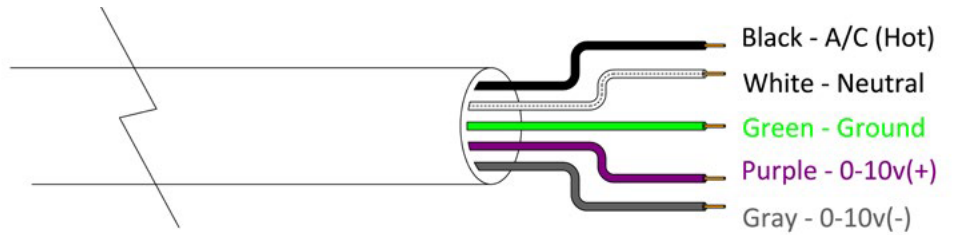

Packaging Dimensions

	4ft			8ft		
	Box	Case	Pallet	Box	Case	Pallet
Qty - Fixtures	1	6	90	1	6	90
Box	52"L x 5"W x 4"H	53"L x 12"W x 12"H	53"L x 40"W x 65"H	98"L x 5"W x 4"H	99"L x 12"W x 12"H	99"L x 30"W x 65"H
Weight	8lbs	50lbs	765lbs	14lbs	85lbs	1300lbs

Dimensional Data

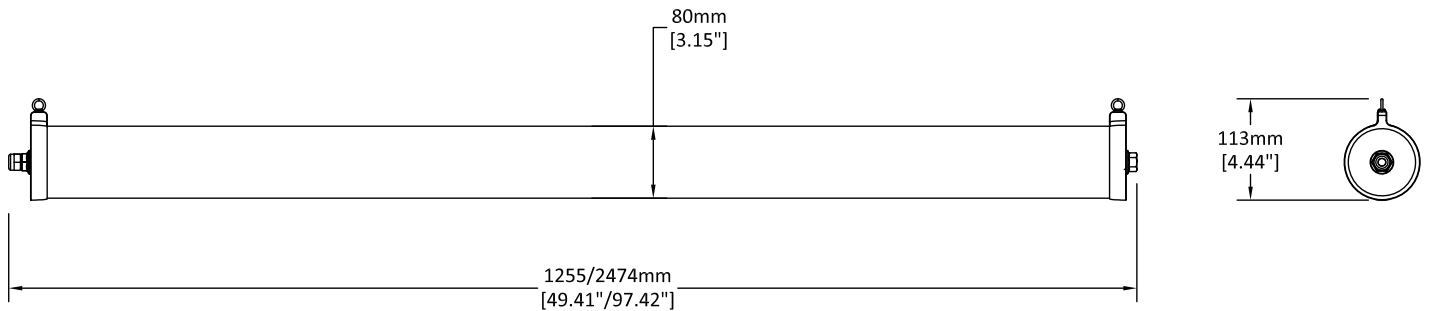

Mounting Options

Surface Bracket and Adjustable Cables included with all LRB fixtures



**Surface Bracket
(Included)**

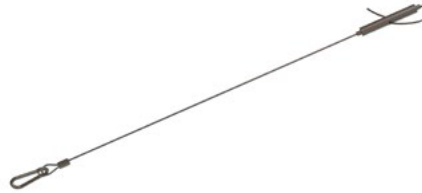
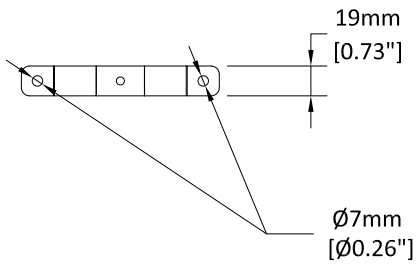
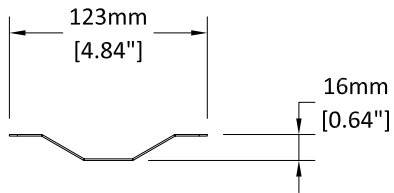

**Adjustable Cable
(Included)**

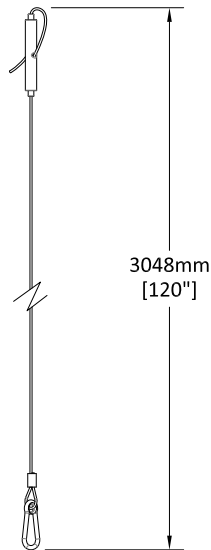

**Wall Mount Bracket
(Order Separately)**

